

BEST CHOICE M&P LTD.

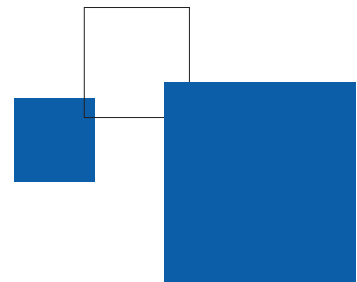

CATERING SUPPLIES

Your one stop professional catering supplies and equipments

CATALOGUE
2018

BEST CHOICE M&P LTD.

Best Choice M&P Limited is a Hong Kong based company founded in 1995 and has since been one of the leading worldwide supplier of commercial catering supplies and equipment. We have established a reputation for our professional quality of goods and outstanding services. Our comprehensive range of products caters all our customer's needs from kitchen to table services, in café, restaurants or hotels.

HONG KONG HEADQUARTER

Our creative staff is constantly serving our customers proactively, developing product ideas and concepts to further expand our ranges. We thrive to provide the best service to our customers, and constantly innovate our products that are safe, efficient, fun, novel and earth friendly.



ZHONG HUAN - OUR CUTLERY FACTORY IN JIANGMEN, CHINA

Was founded in 2008. Owing our own cutlery factory gives us a competitive edge in the fierce cutlery market, allows us to provide the best price, timely delivery and better quality control for our customers. We also invest on providing innovative designs to provide our customers a vast option.

This **Catering Supplies** is one of our four product catalogues - Catering Supplies, Cutleries, Titan Porcelain and Electrical Appliances.

You can always find our latest information and product catalogue online at our website.

[Http://www.bc-hk.com](http://www.bc-hk.com)

Thank you for your interest in our items.



TABLE OF CONTENTS

■ Buffet	1 - 6
■ Gastronorm Pans	7 - 9
■ Cookware	10 - 18
■ Food Preparation	19 - 25
■ Bakware	26 - 27
■ Knives	28 - 31
■ Table Service	32 - 37
■ Coffee and Tea	38 - 40
■ Barware	41 - 45
■ Trolleys	46 - 48
■ Signs and Displays	49
■ Workbenches and Shelves	50 - 51
■ Janitorials	52
■ Sauce and Condiments	53-54
■ Polycarbonate Glasses	55
■ Full Products Index	56 - 59
■ Conversion Charts	60



Our beautiful stainless steel chafing dishes are just perfect for those large special events, holiday gatherings or tailgate parties. These chafing dishes will make food service easy and convenient no matter where you are.

Our full range include Full and Half size chafing dishes, all of them fits traditional fuel burners and some of them can fit the electrical heating plates popular in the market. You can also buy the electrical heating plates from us.

DELUXE CHAFING DISHES

Deluxe Full Size Roll-Top Chafer



- All Stainless Steel Version
- Gold Plate Version

Item#	Size	Capacity
● 733	72x41x(H)46cm	9 L
● 733A	72x41x(H)46cm	9 L

Deluxe Full Size Roll-Top Chafer



Item#	Size	Capacity
● 733GH	80x50x(H)42cm	9 L

Deluxe Round Chafing Dish



- All Stainless Steel Version
- Gold Plate Version

Item#	Size	Capacity
● 731	Ø40x(H)40cm	6L
● 731A	Ø40x(H)40cm	6L

Deluxe Round Chafing Dish



Item#	Size	Capacity
● 731GH	Ø52x(H)45cm	6L

Deluxe Roll-Top Rectangular Soup Station



Item#	Size	Capacity
● 738GH	55x52x(H)45cm	8L

Deluxe Round Soup Station



Item#	Size	Capacity
● 730GH	80x50x(H)42cm	4L

CLASSIC CHAFING DISHES

Full Size Chafing Dish



Item#	Size	Capacity
● 833-TIL	66x35x(H)42cm	9L

Round Chafing Dish



Item#	Size	Capacity
● 835-TIL	44x34x(H)42cm	7.5L

Full Size Chafing Dish



- All Stainless Steel Version
- Gold Plate Version

Item#	Size	Capacity
● 933RC	65x40x(H)35cm	9L
● 933RCA	65x40x(H)35cm	9L



Our buffet chafing dishes make a wonderful serving piece. It uses SternoR to heat water contained in the main dish, together with the heat protected lid cover, keeps your casseroles or side dishes piping hot and enjoyable for hours.

Our Stainless Steel Chafing Dishes aid in creating a beautiful setting with a touch of affordable elegance to the table. These chafers have a mirror-polished stainless steel with elegant legs and handles.

CLASSIC CHAFING DISHES

Full Size Roll-Top Chafer



Item#	Size	Capacity
K900DP	62x36x(H)39cm	9L

Round Chafing Dish



Item#	Size	Capacity
S831	Ø46 x (H)42cm	4.5L

Full Size Roll-Top Chafer



Item#	Size	Capacity
● All Stainless Steel Version ● Gold Plate Version		
● S901	70x48x(H)43cm	9L
● S901K	70x48x(H)43cm	9L

Round Chafing Dish



Item#	Size	Capacity
● All Stainless Steel Version ● Gold Plate Version		
● S701	Ø46 x (H)45cm	6.8L
● S701K	Ø46 x (H)45cm	6.8L

Full Size Roll-Top Chafer



Item#	Size	Capacity
● All Stainless Steel Version ● Gold Plate Version		
● 900	65x37x(H)45cm	9L
● 900GH	65x37x(H)45cm	9L

Full Size Roll-Top Chafer



Item#	Size	Capacity
● All Stainless Steel Version ● Gold Plate Version		
● 200	67x37x(H)50cm	9L
● 200GH	67x37x(H)50cm	9L

Full Size Rectangular Chafer



Item#	Size	Capacity
● All Stainless Steel Version ● Gold Plate Version		
● 933	68x38x(H)35cm	9L
● 933GH	68x38x(H)35cm	9L

Full Size Rectangular Chafer



Item#	Size	Capacity
● All Stainless Steel Version ● Gold Plate Version		
● 233	67x36x(H)32cm	9L
● 233GH	67x36x(H)32cm	9L

Roll-Top Cover

Roll-Top cover for item# 900 & 200



Item#	Size
900L	65X37cm

CLASSIC CHAFING DISHES

Full Size Rectangular Chafer



Item#	Size	Capacity
533A	60x35x(H)35cm	9L

Full Size Rectangular Chafer



Item#	Size	Capacity
033	62x35x(H)33cm	9L

Full Size Rectangular Chafer



Item#	Size	Capacity
833SLT	64x35x(H)36cm	9L

Full Size Rectangular Chafer



Item#	Size	Capacity
833SLR	64x35x(H)36cm	9L

Chafer Rectangular Soup Station



Item#	Size	Capacity
838	66x36x(H)32cm	

Round Chafer w/ Glass Lid & Divided Food Pan



Item#	Size	Capacity
835GL	42x34x(H)32cm	6Qt

CHAFING DISHES ACCESSORIES

Oz Fuel



Item#	Heating Hours
OZ-6	6hrs
OZ-4	4hrs
OZ-2	2hrs

Prime Heat



Item#	Heating Hours
PH-6	6hrs
PH-4	4hrs
PH-2	2hrs

Stainless Steel Fuel Holder



Item#	Size
800F	Ø93x(H)65mm

Heating Plate For Chafing Dishes

HE-001 - Heating Plate provides handy electric heating below a chafing dish or chafing pan. This removable electric chafing dish heater is supported by 4 screws at the bottom of the water pan of the chafing dish. The Heating Plate provides a constant thermal interface to the underside of the chafing dish by an internal PTC heating element.



HE-001



HE-001RD



Technical specifications

AC power supply:	230 ~ 240VAC / 50Hz
Power:	300-400W
Heating plate dimension:	260 x 195mm

Item#	Description
HE-001	Heating Plate for Rectangular Chafing Dish
HE-001RD	Heating Plate for Round Chafing Dish

Full Size Rectangular Chafer



- All Stainless Steel Version
- Gold Plate Version

Item#	Size	Capacity
● 833	65x36x(H)25cm	9L
● 833GH	65x36x(H)25cm	9L

Full Size Rectangular Chafer

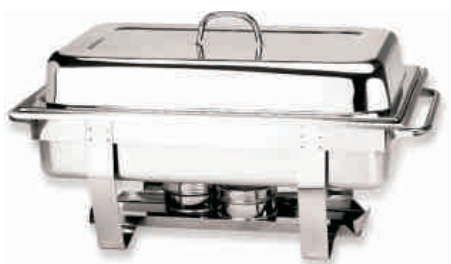

- All Stainless Steel Version
- Gold Plate Version

Item#	Size	Capacity
● 633	61x35x(H)30cm	9L
● 633GH	61x35x(H)30cm	9L

Full Size Rectangular Chafer



- All Stainless Steel Version
- Gold Plate Version

Item#	Size	Capacity
● 433	61x35x(H)32cm	9L
● 433GH	61x35x(H)32cm	9L

Full Size Rectangular Chafer



Item#	Size	Capacity
● PH-433T-01	61x35x(H)32cm	9L

Full Size Rectangular Chafer



Item#	Size	Capacity
● PH-433	60x35x(H)34cm	9L

Oval Chafing Dish



- All Stainless Steel Version
- Gold Plate Version

Item#	Size	Capacity
● 836	55x33x(H)25cm	7.5L
● 836GH	55x33x(H)25cm	7.5L

Round Chafing Dishes

3 Sizes Available



- All Stainless Steel Version
- Gold Plate Version

Item#	Size	Capacity
● 831	30x36x(H)26cm	3.5L
● 831GH	30x36x(H)26cm	3.5L



- All Stainless Steel Version
- Gold Plate Version

Item#	Size	Capacity
● 831L	36x36x(H)26cm	5L
● 831LGH	36x36x(H)26cm	5L



- All Stainless Steel Version
- Gold Plate Version

Item#	Size	Capacity
● 835	36x36x(H)28cm	7.5L
● 835GH	36x36x(H)28cm	7.5L

Half Size Chafing Dish



- All Stainless Steel Version
- Gold Plate Version

Item#	Size	Capacity
● 834	44x31x(H)26cm	4L
● 834GH	44x31x(H)26cm	4L

Half Size Chafing Dish



- All Stainless Steel Version
- Gold Plate Version

Item#	Size	Capacity
● 334	44x31x(H)26cm	4L
● 334GH	44x31x(H)26cm	4L

Jumbo Base Round Chafer



- All Stainless Steel Version
- Gold Plate Version

Item#	Size	Capacity
● H835	36x36x(H)37cm	13.5L
● H835GH	36x36x(H)37cm	13.5L

ECONOMIC SOUP STATIONS

Soup Station - European Style



- All Stainless Steel Version
- Gold Plate Version

Item#	Size	Capacity
● 8307	33x25x(H)30m	7L
● 8311	38x30x(H)30cm	11L
● 8307GH	33x25x(H)30m	7L
● 8311GH	38x30x(H)30cm	11L

Soup Station - American Style



- All Stainless Steel Version
- Gold Plate Version

Item#	Size	Capacity
● BM-8304K	28x20x(H)33cm	4L
● BM-8307K	30x25x(H)33cm	7L
● BM-8311K	35x30x(H)33cm	11L
● BM-8304KGH	28x20x(H)33cm	4L
● BM-8307KGH	30x25x(H)33cm	7L
● BM-8311KGH	35x30x(H)33cm	11L

DELUXE CHAFING DISHES

These new range of chafers are intelligently designed with innovated hinge system, the roll top cover can be pulled down to the frame slowly and avoid slamming.

Deluxe Full Size Chafing Dish with Hinge



(Front View)



(Back View)

Item#	Size	Capacity
IC-133	58x43x(H)42cm	9L

Deluxe 2/3 GN Size Chafer



(Front View)



(Front View)

Deluxe Round Soup Station



Item#	Size	Capacity
IC-111	Ø49 x (H)45cm	11L



(Back View)



(Back View)

Item#	Size	Capacity
IC-132	38x40x(H)42cm	6L

Item#	Size	Capacity
IC-131	55x55x(H)35cm	6L

Apart from regular oz fuel for heating, heating element, warming plate can also be an alternative to these deluxe chafing dish.



Oz Fuel
#OZ-20Z



Heating Element
#HE-001RD



Warming Plate
#WP-001

DELUXE JUICE DISPENSERS

Our Deluxe Juice Dispenser series has shining Stainless Steel base with traditional design. The dispenser has 8 litres capacity and a stainless steel central tube design that helps to chill beverages without watering them down.



The elegant design of the juice dispenser acts as a classic way to serve juice or your beverage of choice, and is a beautiful presentation on your buffet table.

Juice Dispenser w/ Stainless Steel Body



Item#	Size	Capacity
D0041	35x26(H)58cm	8L

Double Head Juice Dispenser w/ Clear Plastic Body



Item#	Size	Capacity
D0032	56x35(H)59cm	8Lx2

Juice Dispenser w/ Clear Plastic Body



Item#	Size	Capacity
D0031	35x26x(H)59cm	8L

Double Head Juice Dispenser w/ Stainless Steel Body



Item#	Size	Capacity
D0042	56x35(H)58cm	8Lx2

ECONOMIC JUICE DISPENSERS

Comes in Single, Double & Triple Heads

Circular Dispenser



Item#	Size	Capacity
D0031P	26x35x(H)59cm	8L
D0032P	56x35x(H)59cm	8Lx2
D0033P	86x35x(H)59cm	8Lx3

Cylinder Dispenser



Item#	Size	Capacity
D0051P	21.5x31.5x(H)50cm	3L
D0052P	41.5x31.5x(H)50cm	3Lx2
D0053P	61.5x31.5x(H)50cm	3Lx3

Hexagon Dispenser



Item#	Size	Capacity
D0061P	21.5x31.5x(H)50cm	3L
D0062P	41.5x31.5x(H)50cm	3Lx2
D0063P	61.5x31.5x(H)50cm	3Lx3

CEREAL DISPENSERS

FEATURES

- Tough polycarbonate body
- Stainless steel fittings and base
- Easy to turn wheel to dispense cereal
- Available in double or single models

Item#	Description	Capacity
● 10301	Cereal Dispenser	5L
● 10302	Double Cereal Dispenser	5Lx2



Our Gastronorm containers are made from the finest heavy duty stainless steel with specially designed reinforced corners to provide exceptional durability and long life.

Despite their excellent versatility for sorting sauces and ingredients, they are great for cooking, serving and displaying all the way in the same pan.

- Various grade of Stainless Steel available
- Durable & hardwearing
- Dishwasher safe
- Available in standard or perforated design
- **Available in European Style, American Style & Italian Style Gastronorm Pans**

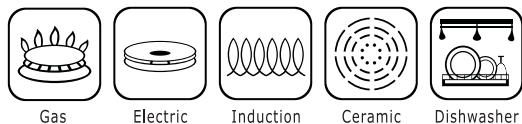

GN 1/1 Full Size, 530 x 325mm

Item#	Depth
811-20	20mm
811-40	40mm
811-2	65mm
811-4	100mm
811-6	150mm
811-8	200mm
811L	Plain Cover
811LN	Notched Cover

GN 1/4 Size, 265 x 162mm

Item#	Depth
814-2	65mm
814-4	100mm
814-6	150mm
814-8	200mm
814L	Plain Cover
814LN	Notched Cover

GN 2/3 Size, 355 x 325mm

Item#	Depth
823-20	20mm
823-40	40mm
823-2	65mm
823-4	100mm
823-6	150mm
823-8	200mm
823L	Plain Cover
823LN	Notched Cover

GN 1/6 Size, 176 x 162mm

Item#	Depth
816-2	65mm
816-4	100mm
816-6	150mm
816-8	200mm
816L	Plain Cover
816LN	Notched Cover

GN 1/2 Size, 325 x 265mm

Item#	Depth
812-20	20mm
812-40	40mm
812-2	65mm
812-4	100mm
812-6	150mm
812-8	200mm
812L	Plain Cover
812LN	Notched Cover

GN 1/9 Size, 176 x 108mm

Item#	Depth
819-2	65mm
819-4	100mm
819-6	150mm
819L	Plain Cover
819LN	Notched Cover

GN 1/3 Size, 325 x 176mm

Item#	Depth
813-20	20mm
813-40	40mm
813-2	65mm
813-4	100mm
813-6	150mm
813-8	200mm
813L	Plain Cover
813LN	Notched Cover

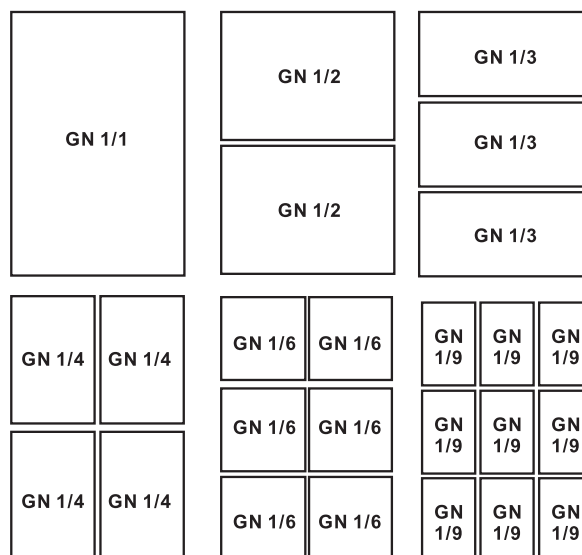



The Gastronorm containers from Best Choice stand out thanks to their particularly high quality and durability. Without Gastronorms containers, handling food is almost child's play: Acceptance of goods - storage - preparation - cooking/simmering/steaming - serving.

STAINLESS STEEL PERFORATED GASTRONORMS

GN 1/1 Full Size, 530 X 325mm



Item#	Depth
811-20P	20mm
811-40P	40mm
811-2P	65mm
811-4P	100mm
811-6P	150mm
811-8P	200mm

GN 2/3 Size, 355 X 325mm



Item#	Depth
823-20P	20mm
823-40P	40mm
823-2P	65mm
823-4P	100mm
823-6P	150mm
823-8P	200mm

GN 1/2 Full Size, 325 X 265mm



Item#	Depth
812-20P	20mm
812-40P	40mm
812-2P	65mm
812-4P	100mm
812-6P	150mm
812-8P	200mm

Gastronorm Pan Handle & Strainer



One for Straining



Two for Carrying



- No more food down the drain
- Stops contamination from Dirty potholders etc.

Item#
PG-245

Adaptor Bar



Item#	Size
ADP-12	12"
ADP-21	21"

Drain Plate for GN Pans



Item#	Size
811DP	1/1 Size Drain Plate
812DP	1/2 Size Drain Plate
813DP	1/3 Size Drain Plate
814DP	1/4 Size Drain Plate
816DP	1/6 Size Drain Plate

Stainless Steel GN Pan Holders



Item#	Suitable for No. Of Pans		
	GN1/2	GN1/3	GN1/6
● R813-2		2	4
		1	2
			6
● R816-6		1	4
		2	2
		1	3
	1	1	1

Clear, durable and convenient. These Polycarbonate gastronorms pans and lids offer a real alternative to stainless steel. Virtually unbreakable, non stick and easy to clean, they have an excellent temperature range of -40C - +100C. Also they will not bend or dent, are easy to touch and quiet in use.



Dishwasher



Drain Shelf



Cover



GN 1/1 Full Size, 530 x 325mm

GN 1/1	Item#	Depth
	P811-2	65mm
	P811-4	100mm
	P811-6	150mm
	P811-8	200mm
	P811L	Plain cover
P811DS	Drain shelf	

GN 1/4 Size, 265 x 162mm

GN 1/4	Item#	Depth
	P814-2	65mm
	P814-4	100mm
	P814-6	150mm
P814L	Plain Cover	

GN 1/6 Size, 176 x 162mm

GN 1/6	Item#	Depth
	P816-2	65mm
	P816-4	100mm
	P816-6	150mm
P816L	Plain Cover	

GN 1/2 Size, 325 x 265mm

GN 1/2	Item#	Depth
	P812-2	65mm
	P812-4	100mm
	P812-6	150mm
	P812-8	200mm
	P812L	Plain Cover
P812DS	Drain shelf	

GN 1/9 Size, 176 x 108mm

GN 1/9	Item#	Depth
	P819-2	65mm
	P819-4	100mm
	P819-6	150mm
P819L	Plain Cover	

GN 1/3 Size, 325 x 176mm

GN 1/3	Item#	Depth
	P813-2	65mm
	P813-4	100mm
	P813-6	150mm
	P813-8	200mm
	P813L	Plain Cover
P813DS	Drain shelf	

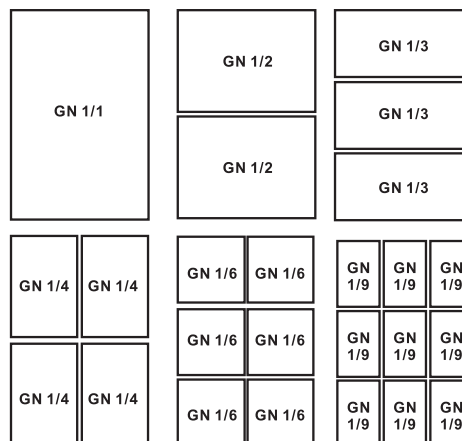

Three layers Sandwich type bottom collection stockpots and pans are constructed of durable, shiny stainless steel. The bottoms on the pans feature an encapsulated aluminum disk between two layers of stainless steel for quick and even heat distribution.

- Made of Extra thick, premium quality stainless steel
- Heavy-gauge handles are designed for ease & comfort
- Heavy-duty, tight-fitting lids to seal in the flavours & nutrients
- Handles are permanently welded for maximum durability & long life
- No rolled edges for easier cleaning & pouring
- All pieces are completely oven proof & dishwasher safe
- Completely sandwich type bottom provides superior heat conduction with no "hot spots" to prevent burning foods
- Will not warp

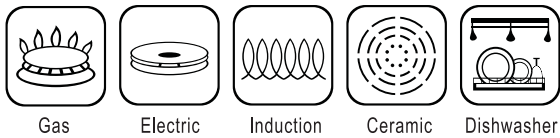
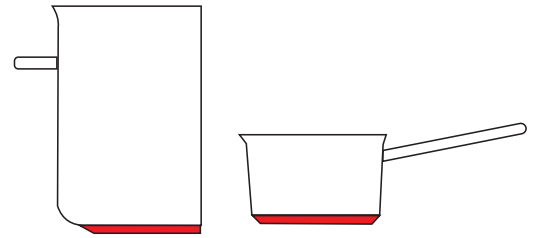

Offers flexible order quantity
SS304 & Eco stainless steel
are both available

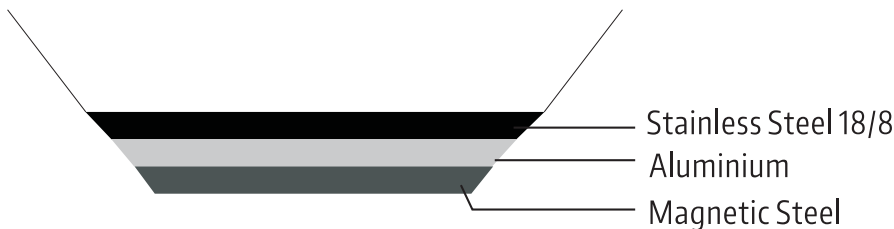

- All lids are made with 3-points steam release holes
- Solid handles with multi-spots welding enhance durability
- Dishwasher safe, acid-resistant
- Suitable for all heat source
- Body is made of high grade stainless steel 304

(Economic grade stainless steel is also available as per customers' needs)

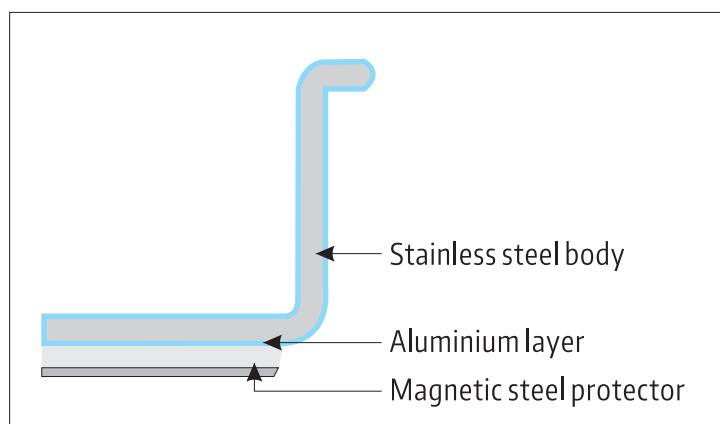
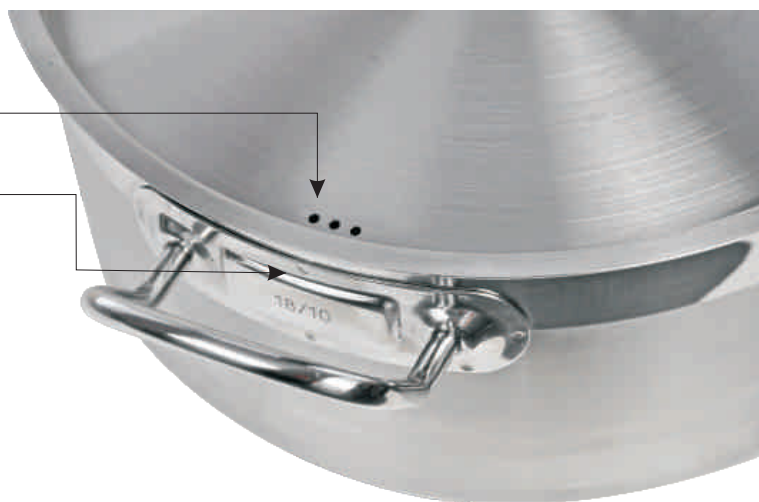

Sandwich type bottom = Aluminium layer (5.0mm) + Magnetic steel protector (0.5mm)

STOCK POT PAN

Item#	Size	Capacity	Body	Lid
STL1675-SW	Ø160 x (H) 75mm	1.5L	0.7mm	1mm
STL1611-SW	Ø160 x (H) 110mm	2L	0.7mm	1mm
STL1615-SW	Ø160 x (H) 150mm	3L	0.7mm	1mm
STL2090-SW	Ø200 x (H) 90mm	2.8L	0.7mm	1mm
STL2013-SW	Ø200 x (H) 130mm	4L	0.7mm	1mm
STL2019-SW	Ø200 x (H) 190mm	6L	0.7mm	1mm
STL24105-SW	Ø240 x (H) 105mm	4.7L	0.7mm	1mm
STL2415-SW	Ø240 x (H) 150mm	6.8L	0.7mm	1mm
STL2422-SW	Ø240 x (H) 220mm	10L	0.7mm	1mm
STL2812-SW	Ø280 x (H) 120mm	7.4L	0.7mm	1mm
STL2817-SW	Ø280 x (H) 170mm	10L	0.7mm	1mm
STL2826-SW	Ø280 x (H) 260mm	16L	0.7mm	1mm
STL3215-SW	Ø320 x (H) 150mm	12L	0.8mm	1mm
STL3219-SW	Ø320 x (H) 190mm	15L	0.8mm	1mm
STL3230-SW	Ø320 x (H) 300mm	24L	0.8mm	1mm
STL3617-SW	Ø360 x (H) 170mm	17L	1mm	-
STL3623-SW	Ø360 x (H) 230mm	24L	1mm	-
STL4019-SW	Ø400 x (H) 190mm	24L	1mm	-
STL4025-SW	Ø400 x (H) 250mm	31L	1mm	-

Sandwich Bottom Pots and Pans



Sandwich type bottom

Aluminium layer (4.0mm)

+ Magnetic steel protector (0.8mm)



STOCK POT PAN

Item#	Size	Capacity		
STL3636-SW	Ø360 x (H) 360mm	41.5L	1mm	1mm
STL4040-SW	Ø400 x (H) 400mm	50L	1mm	1mm
STL4545-SW	Ø450 x (H) 450mm	71L	1.2mm	1.2mm
STL5050-SW	Ø500 x (H) 500mm	98L	1.2mm	1.2mm

SAUCE PAN

Item#	Size	Capacity
SP1470-SW	Ø140 x (H) 70mm	1.2L
SP1675-SW	Ø160 x (H) 75mm	1.5L
SP1880-SW	Ø180 x (H) 80mm	2L
SP2090-SW	Ø200 x (H) 90mm	3L



CONICAL PAN

Item#	Size	Capacity
CP1660-SW	Ø160 x (H) 60mm	0.9L
CP1860-SW	Ø180 x (H) 60mm	1.3L
CP2060-SW	Ø200 x (H) 60mm	1.5L
CP2460-SW	Ø240 x (H) 60mm	1.8L



FRYING PAN

Item#	Size	Capacity
FP2040-SW	Ø200 x (H) 40mm	1.3L
FP2450-SW	Ø240 x (H) 50mm	2L
FP2850-SW	Ø280 x (H) 50mm	3.6L
FP3255-SW	Ø320 x (H) 55mm	4.8L



Three layers Encapsulated bottom collection stockpots and pans are constructed of durable, shiny stainless steel. The bottoms on the pans feature an encapsulated aluminum disk between two layers of stainless steel for quick and even heat distribution.

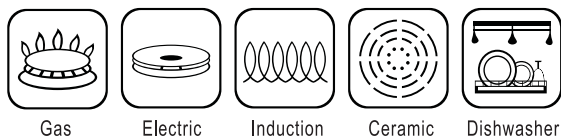

Gas

Electric

Induction

Ceramic

Dishwasher

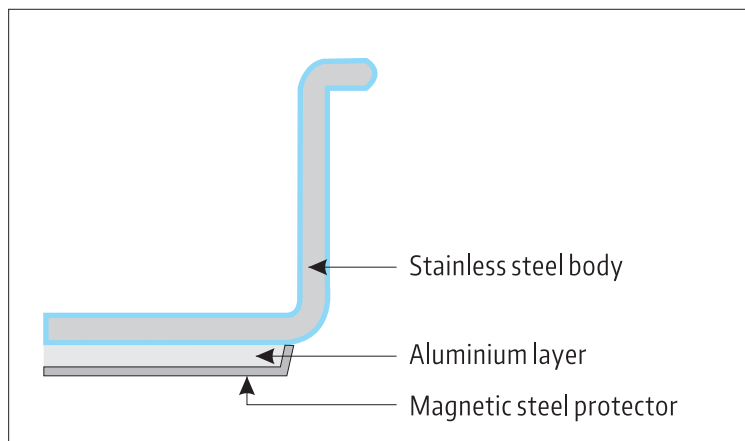

Encapsulated bottom=

Pot/Pan Size Ø320-400mm: Aluminium layer (5.0mm) + Magnetic steel protector (0.5mm)

Pot/Pan Size Ø160-280mm: Aluminium layer (4.0mm) + Magnetic steel protector (0.5mm)

STOCK POT PAN

Item#	Size	Capacity	Body	
STL1675	Ø160 x (H) 75mm	1.5L	0.7mm	0.7mm
STL1695	Ø160 x (H) 96mm	1.9L	0.7mm	0.7mm
STL1614	Ø160 x (H) 140mm	2.8L	0.7mm	0.7mm
STL2095	Ø200 x (H) 95mm	3L	0.7mm	0.7mm
STL20115	Ø200 x (H) 115mm	3.6L	0.7mm	0.7mm
STL2016	Ø200 x (H) 160mm	5L	0.7mm	0.7mm
STL24115	Ø240 x (H) 115mm	5.2L	0.7mm	0.7mm
STL24135	Ø240 x (H) 135mm	6L	0.7mm	0.7mm
STL2420	Ø240 x (H) 200mm	9L	0.7mm	0.7mm
STL2812	Ø280 x (H) 120mm	7.4L	0.7mm	0.7mm
STL28155	Ø280 x (H) 155mm	9.5L	0.7mm	0.7mm
STL2822	Ø280 x (H) 220mm	13.5L	0.7mm	0.7mm
STL3215	Ø320 x (H) 150mm	12L	0.8mm	0.8mm
STL3219	Ø320 x (H) 190mm	15L	0.8mm	0.8mm
STL3225	Ø320 x (H) 250mm	20L	0.8mm	0.8mm
STL3227	Ø320 x (H) 270mm	22L	0.8mm	0.8mm
STL3617	Ø360 x (H) 170mm	17L	1mm	1mm
STL3623	Ø360 x (H) 230mm	23L	1mm	1mm
STL4019	Ø400 x (H) 190mm	23.8L	1mm	1mm
STL4025	Ø400 x (H) 250mm	31L	1mm	1mm

SAUCE PAN

Item#	Size	Capacity
SP1675	Ø160 x (H) 75mm	1.5L
SP2095	Ø200 x (H) 95mm	3L
SP24415	Ø240 x (H) 115mm	5.2L



CONICAL PAN

Item#	Size	Capacity
CP1660	Ø160 x (H) 60mm	0.9L
CP2060	Ø200 x (H) 60mm	1.5L



FRYING PAN

Item#	Size	Capacity
FP2450	Ø240 x (H) 50mm	2L
FP2850	Ø280 x (H) 50mm	3.6L
FP3255	Ø320 x (H) 55mm	4.8L



- Solid handles with multi-spots welding that enhance durability
- Dishwasher safe, acid-resistant
- Suitable for all heat source
- Body is made of high grade stainless steel SUS304

(Economic grade stainless steel is also available as per customers' needs)



If you get serious in the kitchen, use All-Clad, the choice of professional chefs. A 3-ply bonded construction with a pure aluminum core provides you with even heat distribution and a non-reactive stainless-steel interior and exterior. Long, riveted, stay-cool handles and SUS304 stainless steel lids round off the stylish look. Dishwasher safe. For use on all stovetops including induction stovetops.

Brushed stainless exterior is easy to clean and resists fingerprints Dishwasher Safe Tight-fitting, heavy weight lids lock in moisture and flavor

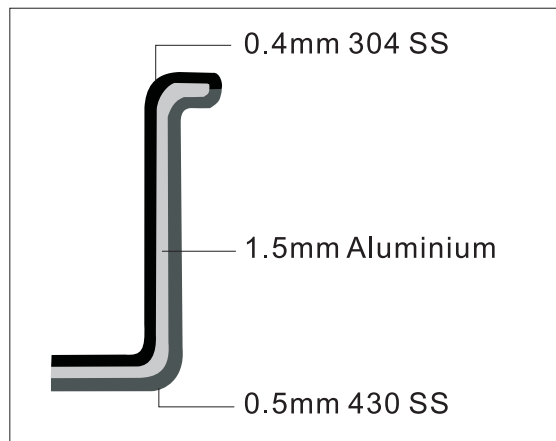
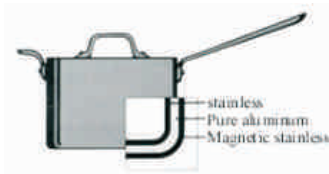
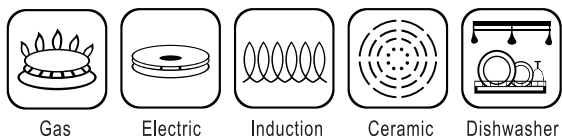

STOCK POT PAN



Item#	Size
STL1675-3	Ø160 x (H) 75mm
STL2095-3	Ø200 x (H) 95mm
STL24115-3	Ø240 x (H) 115mm
STL2416-3	Ø240 x (H) 160mm
STL2818-3	Ø280 x (H) 180mm
STL2813-3	Ø280 x (H) 130mm
STL3215-3	Ø320 x (H) 150mm
STL3220-3	Ø320 x (H) 200mm

CONICAL PAN



Item#	Size
CP207-3	Ø200 x (H) 70mm
CP2275-3	Ø220 x (H) 75mm

SAUCE PAN



Item#	Size
SP1875-3	Ø180 x (H) 75mm
SP1885-3	Ø180 x (H) 55mm

FRYING PAN



Item#	Size
FP245-3	Ø240 x (H) 50mm
FP285-3	Ø280 x (H) 50mm

Round Casserole w/ Knob Lid



● Red Colour
● Black Colour

Item#	Capacity	Item#	Capacity
● BEC-3A-RE	2.5L	● BEC-3A-BL	2.5L
● BEC-3B-RE	3.8L	● BEC-3B-BL	3.8L
● BEC-3C-RE	5.4L	● BEC-3C-BL	5.4L

Mini Round Cocotte w/ Knob Lid



● Red Colour
● Black Colour

Item#	Capacity	Item#	Capacity
● BEC-5A-RE	0.25L	● BEC-5A-BL	0.25L

Rectangular Dish 7L

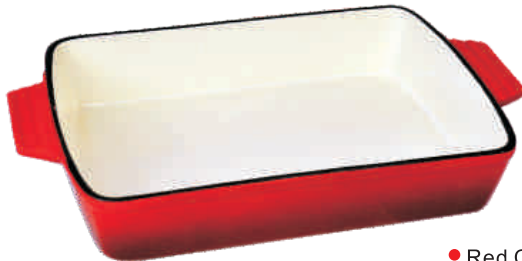

● Red Colour
● Black Colour

Item#	Capacity	Item#	Capacity
● BEC-9A-RE	38.5x23.5x(H)6.5cm	● BEC-9A-BL	23.5x(H)6.5cm

Oval Gratin



● Red Colour
● Black Colour

Item#	Size	Capacity
● BEC-11A-RE	26x(H)15.5cm	0.65L
● BEC-11A-BL	26x(H)15.5cm	0.65L
● BEC-11B-RE	26x(H)15.5cm	1.65L
● BEC-11B-BL	26x(H)15.5cm	1.65L

Oval Casserole w/ Knob Lid



● Red Colour
● Black Colour

Item#	Capacity	Item#	Capacity
● BEC-4A-RE	4.5L	● BEC-4A-BL	4.5L
● BEC-4B-RE	6L	● BEC-4B-BL	6L
● BEC-4C-RE	7.5L	● BEC-4C-BL	7.5L

Mini Oval Cocotte w/ Knob Lid



● Red Colour
● Black Colour

Item#	Capacity	Item#	Capacity
● BEC-6A-RE	0.35L	● BEC-6A-BL	0.35L

Rectangular Dish



● Red Colour
● Black Colour

Item#	Capacity	Item#	Capacity
● BEC-10A-RE	0.4L	● BEC-10A-BL	0.4L
● BEC-10B-RE	0.75L	● BEC-10B-BL	0.75L

Pate Terrine Dish



● Red Colour
● Black Colour

Item#	Capacity	Item#	Capacity
● BEC-9A-RE	34x11x(H)8.5cm	● BEC-9A-BL	34x11x(H)8.5cm

Cast Iron Pot



Item#	Size
H317	185mm

Fry Pans



Item#	Capacity	Item#	Capacity
FP007	178mm	FP014	356mm
FP010	254mm	FP016	406mm
FP012	305mm		

Enamel Egg Dish



Item#	Size
CI-19	160mm

Enamel Platter w/ Wooden Stand



Item#	Size
CI-1	270 x 210 x 25mm

Oval Sizzle Platter w/ Board



Item#	Board Size	Item#	Board Size
H995	241cm	H911	279cm

- Oval Sizzle Platter w/ Board
- Reversible Double Griddle



Item#	Board Size	Item#	Size
● H917	305mm	● H205	432mm

Oval Sizzle Platter w/ Board



Item#	Board Size
H913	330m

Round Sizzle Platter



Item#	Size
HL950	Ø240mm

Oval Sizzle Platter w/ Board



Item#	Size
H66	241mm

Skillet



Item#	Board Size	Item#	Size
H71	230mm	H72	267mm

Ribbed Skillet



Item#	Board Size
● H71-4	203mm
● H72-4	267mm

Bull Shaped Sizzle Platter w/ Board



Item#	Size
H912-B	305mm

Pig Shaped Sizzle Platter w/ Board



Item#	Size
H912-P	318mm

Squarish Sizzle Platter w/ Adjustable Handle



Item#	Size
HH2244	235 x 220 x 20mm

Rectangular Sizzle Platter w/Adjustable Handle



Item#	Size
HH3621	355 x 205 x 20mm



HDPE Chopping Board

Item#	Size
HCB1209-3	305x230x(H)19mm
HCB1218-2	305x460x(H)13mm
HCB1218-3	305x460x(H)19mm
HCB1824-3	610x460x(H)19mm
HCB0608-6	205x150x(H)38mm

LDPE Chopping Board

Item#	Size
CB1218-2E	305x460x(H)13mm
CB1218-3E	305x406x(H)19mm
CB1519-3E	380x490x(H)19mm
CB1824-3E	460x610x(H)19mm
CB1824-4	460x610x(H)25mm



Bamboo Chopping Board



Item#	Size
YB-1	Ø200 x (H) 20mm
YB-2	Ø250 x (H) 20mm
YB-3	Ø300 x (H) 20mm
YB-4	Ø350 x (H) 20mm
YB-5	Ø400 x (H) 20mm
YB-6	Ø450 x (H) 20mm

Bamboo Chopping Board



Item#	Size
FB-1	300 x 200 x (H) 20mm
FB-2	340 x 200 x (H) 20mm
FB-3	380 x 280 x (H) 20mm
FB-4	400 x 300 x (H) 20mm
FB-5	450 x 340 x (H) 20mm
FB-6	650 x 400 x (H) 20mm
FB-7	800 x 500 x (H) 20mm
FB-8	1000 x 600 x (H) 20mm

Wooden Chopping Board



Item#	Size
BB2202	480x320x(H)20mm

Wooden Chopping Board



Item#	Size
W0609	152 x 229 x (H)25mm
W1218	305 x 457 x (H)44mm
W1520	381 x 508 x (H)44mm
W1824	457 x 610 x (H)44mm

Wooden Chopping Board



Item#	Size
BB405305	405x305x(H)20mm

Wooden Chopping Board



Item#	Size
BB255	Ø255mm

Wooden Chopping Board



Item#	Size
BB30520	305x200x(H)20mm

Stainless Steel Strainer



Item#	Size	Item#	Size
439	Ø140mm	438	Ø230mm
436	Ø190mm		

Jumbo Double Mesh Strainer

- Stainless steel



Item#	Size
WK235W	Ø235 x (L) 305mm
WK265W	Ø265 x (L) 305mm
WK315W	Ø315 x (L) 360mm
WK350W	Ø350 x (L) 360mm

Stainless Steel Strainer



Item#	Size	Item#	Size
620W	Ø140mm	660W	Ø240mm
650W	Ø200mm		

Stainless Steel Strainer

- Stainless steel 18/8



Item#	Size
SS18	180mm
SS22	220mm
SS26	260mm

Fat Skimmer

- Stainless steel



Item#	Size
WW4210	Ø203mm

Stainless Steel Fat Skimmer



Item#	Size	Item#	Size
WW4235	Ø140mm	WW4242	Ø200mm
WW4240	Ø160mm	WW4244	Ø240mm

Wire Mesh Skimmer

- Stainless steel



Item#	Size	Item#	Size
WK120	Ø120x410mm	WK200	Ø200x410mm
WK130	Ø140x410mm	WK240	Ø240x405mm
WK160	Ø160x410mm	WK255	Ø255x405mm
WK180	Ø180x410mm		

Nickel Plated Skimmer



Item#	Size	Item#	Size
IR1305	Ø127mm	IR1308	Ø203mm
IR1306	Ø152mm	IR1309	Ø229mm
IR1307	Ø178mm	IR1312	Ø305mm

Rice Spoon Perforated

- Stainless steel



Item#	Size
WW4257	(L)250mm

Stainless Steel Skimmer



Item#	Size	Item#	Size
S8008	Ø80x(L) 390mm	S8012	Ø120x(L) 470mm
S8010	Ø100x(L) 440mm		

Serving Spoon Perforated

- Stainless steel



Item#	Size in Length
S8018P	(L) 457mm

Stainless Steel Soup Ladles



Item#	Size	Item#	Size	Item#	Size	Item#	Size
L8005	Ø50mm	L8008	Ø80mm	L8010	Ø100mm	L8014	Ø140mm
L8006	Ø65mm	L8009	Ø90mm	L8012	Ø120mm	L8016	Ø160mm

Serving Spoon

- Stainless steel



Item#	Size in Length
S8018	(L) 457mm

Stainless Steel Turner



Item#	Size
T8018	(L) 457mm

Turner, Perforated

- Stainless steel



Item#	Size
T8018P	(L) 457mm

Vegetable Strainer

- Stainless steel



Item#	Size
WW4259	Ø220 x (H) 420mm
WW4258	Ø290 x (H) 940mm

Bird Nest Mould

- Stainless steel



Item#	Size
WW4201	76mm & 102mm
WW4202	102mm & 127mm

Vegetable Ladle

- Stainless steel



Item#	Size
WW4257	Ø90mm x (L)203mm

Pea Ladle

- Stainless steel



Item#	Size
WW4255	63mm

Pea Ladle w/ Plastic Handle

- Stainless steel



Item#	Size
WK4255P	63mm

Chip Shovel

- Stainless steel



Item#	Size	Mesh Gauze
WW4230N	203mm	50

Chip Shovel

- Stainless steel



Item#	Size	Mesh Gauze
WK4229	203mm	30
WK4230	203mm	50
WK4231	203mm	80

Chip Shovel w/ Flat Handle

- Stainless steel



Item#	Size	Mesh Gauze
WW4221	203mm	6 x 6

Chip Shovel w/ Flat Handle

- Stainless steel



Item#	Size	Mesh Gauze
WW4220N	203mm	6 x 6

Chip Shovel

- Stainless steel



Item#	Size
WW4208	105mm

Chip Lifter

- Stainless steel



Item#	Size	Mesh Gauze
WW4215	Ø127mm	6 x 6

Fish Lifter w/ Flat Handle

- Stainless steel



Item#	Size	Mesh Gauze
WW4223	203mm	6 x 6

EGG WHISKS, PLASTIC SEALED

8-Wire Egg Whisks

Item#	Size
82325XP	250mm
82330XP	300mm
82335XP	350mm
82340XP	400mm
82345XP	450mm
82350XP	500mm
82355XP	550mm

12-Wire Egg Whisks

Item#	Size
1225XP	250mm
1230XP	300mm
1235XP	350mm
1240XP	400mm
1245XP	450mm
1250XP	500mm

Potato Masher

- Stainless steel

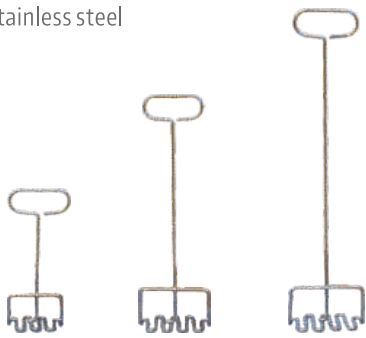

Item#	Size in Length
PM-35CM	350mm
PM-60CM	600mm
PM-77CM	770mm

Potato Masher, Circular

- Stainless steel



Item#	Capacity
WW4307	660mm
WW4308	900mm

Potato Masher, Squared

- Stainless steel with plastic handle



Item#	Size in Length
WW4205	550mm

Potato Masher, Round

- Stainless steel with plastic handle



Item#	Size in Length
WW4206	330mm

Chips Colander

- Stainless steel



Item#	Size
CC-40CM	Ø410x(H)170mm

Pasta Cooker Insert

- Stainless steel



Item#	Size
PCI-1/4	

Fry Basket

- Stainless steel



Item#	Size
WW2973	Ø220x(H)105mm
WW2970	Ø250x(H)140mm
WW2971	Ø270x(H)160mm

Spaghetti Basket

- Stainless steel



Item#	Size
WW4250	Ø150mm

Chip Basket

- Stainless steel



Item#	Size
WW2975	Ø300x(H)300mm

S/S Mini Fry Basket, Slanted

- Wire Ø4mm, basket Ø0.8mm



Item#	Size
FB620	105x90x(H)70mm
FB621	130x100x(H)85mm

S/S Mini Fry Basket, Circular

- Wire Ø4mm, basket Ø0.8mm



Item#	Size
FB600	Ø80x(H)80mm
FB601	Ø90x(H)90mm

S/S Mini Fry Basket, Rectangular

- Wire Ø4mm, basket Ø0.8mm



Item#	Size
FB610	215x105x(H)35mm
FB611	260x130x(H)45mm

WIRE RACKS

Chopping Board Rack

- Stainless steel



Item#	Capacity
J251	Holds 6 boards

Chopping Board Rack

- Stainless steel



Item#	Capacity
WW2965	Holds 6 boards

Shelf Bracket

- Stainless steel



Item#
WW5329

Plate Rack

- Stainless steel

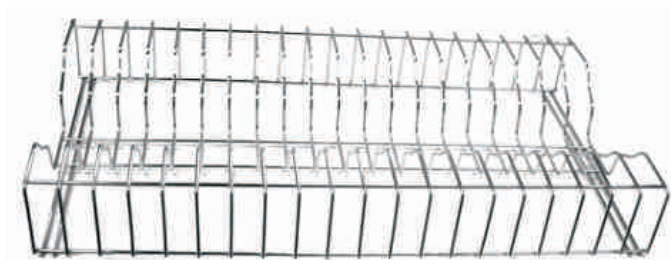

Item#	Size	Plates
WW5330	610X330X80mm	20
WW5331	910X330X80mm	30

Roasting Grill Rack

- Stainless steel



Item#	Size
WW814	500x300x(H)440mm

Grill Pan Trivet

- Stainless steel

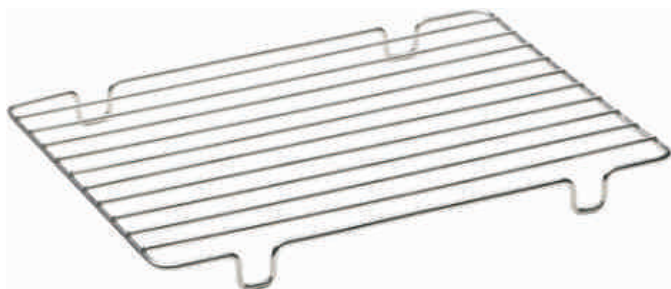

Item#
WW910

Cooling Rack

- Stainless steel

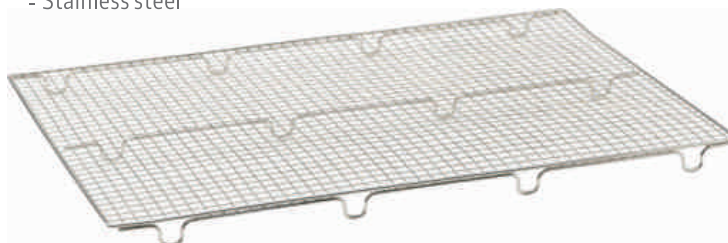

Item#	Size
WK2788	330 x 230mm
WK2789	470 x 260mm
WK2790	630 x 410mm

Gastronorm Grid, GN1/1

- Stainless steel



Item#	Size
WR-5332	530x325mm

Chrome Plated Stainless Steel Wire Rack



Item#	Size
WK2788	190x240x200mm

Serving Tong



Item#	Size
127S	230mm
127M	300mm
127L	400mm

Serving Tong

- Polycarbonate
- HACCP colour coded



Item#
PT-010



For general use
For raw meat
For cooked meats
For salad and fruit
For raw fish
For vegetables
For dairy and bakery

Pasta Slicer



Item#	Size
QF-150	150mm
QF-180	180mm

Mandoline Vegetable Slicer, Manual

- Stainless steel



Item#	Size	Blades
VS-Q2	115x400mm	3 blades (4, 6, 10mm)

Meat Hammer



Item#	Size	Weight
SH-101	257mm	440g
SH-102	225mm	200g
SH-103	257mm	380g

Grater, 4 Sided

- Stainless steel



Item#	Size
2080	90x65x(H)200mm
2090	110x70x(H)230mm

Egg Slicer



Item#
K120C

CHROME PLATED CITRUS JUICERS

Our Lever Juicers stands for More Speed, More Power and More Juice. Our Lever Juicer series is an excellent choice for extracting the juice from all citrus fruits.

Juices: Oranges, Grapefruits, Lemons, Limes, Tangelos, Mandarins and more!

Professional restaurant design to meet both commercial and home demand.



F2001

F2002

F2003

F2004



These heavy duty aluminium bakewares provide excellent heat distribution and durability. Our professional and hygienic products are for the commercial industry.

ALUMINIUM BAKEWARE

Baking Box without Handles

Item#	Size
BCBH1153	400x258x32mm
BCBH1152	400x258x45mm
BCBH1159	400x258x57mm
BCBH1151	400x258x83mm
BCBH1253	200x258x32mm
BCBH1252	200x258x45mm
BCBH1259	200x258x57mm
BCBH1251	200x258x83mm



Baking Trays



Item#	Size
BCM1012	318x216x19mm
BCM1014	368x267x19mm
BCM1016	419x305x19mm
BCM1018	470x356x19mm
BCM1020	521x419x19mm
BCM1026	654x451x25mm



Bakewell Pans

Item#	Size
BCM1112	318x216x38mm
BCM1114	318x267x38mm
BCM1116	419x305x38mm
BCM1118	470x356x38mm
BCM1120	521x419x38mm
BCM1124	610x457x38mm
BCM1126	450x325x40mm
BCM1128	650x450x40mm

Baking Pans

Item#	Size
BCM1212	Baking Pan 318x216x51mm
BCM1214	Baking Pan 368x267x70mm
BCM1216	Baking Pan 419x305x70mm
BCM1218	Baking Pan 470x356x70mm
BCM1220	Baking Pan 521x419x70mm
BCM1224	Baking Pan 610x457x70mm

ROASTING DISHES



Roasting Dish with Built in Handles

Item#	Size
BCM1312	318x216x51mm
BCM1314	368x267x70mm
BCM1316	419x305x70mm
BCM1318	470x356x70mm
BCM1320	521x419x70mm
BCM1324	610x451x70mm

Roasting Dish Deep with Built in Handles

Item#	Size
BCM1416	419x305x102mm
BCM1418	470x356x102mm
BCM1420	521x419x102mm
BCM1424	610x457x102mm

Roasting Dish Extra Deep with Built in Handles

Item#	Size
BCM1616	419x305x152mm
BCM1618	470x356x152mm
BCM1620	521x419x152mm
BCM1624	610x457x152mm

Additional Sizes

Item#	Size
BCM1810	450x325x25mm
BCM1812	530x325x25mm
BCM1814	650x450x25mm
BCM1816	600x400x20mm
BCM1818	600x400x70mm
BCM1820	600x400x100mm
BCM1026	450x325x20mm
BCM1122	532x325x20mm

Stainless Steel Oven Pan



Item#	Size
RT-4036	440x360x(H) 71mm
RT-4236.5	440x365x(H) 73mm
RT-4437	440x370x(H) 75mm

Terrine Mould U Shape

- Stainless steel in mirror polished finish



Item#	Size	Capacity
AP040	135x40x(H)45mm	0.16L
AP034	260x80x(H)75mm	1L
AP030	500x100x(H)90mm	3.5L

Dariol Mould

- Anodised aluminium with rolled edge

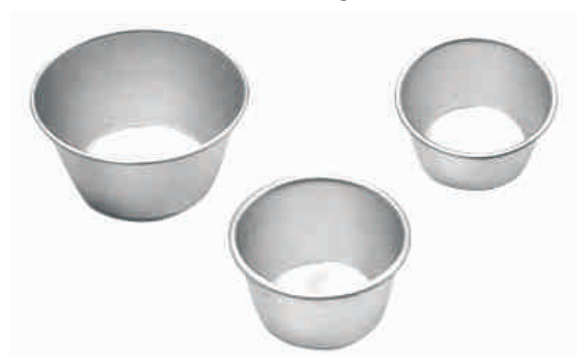

Item#	Size	Item#	Size
N0351	Ø78mm	N0353	Ø89mm
N0352	Ø83mm		

Pyramid Mould

- Stainless steel
- Mirror polished finish

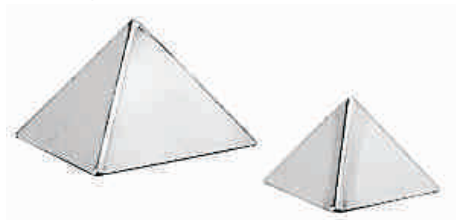

Item#	Size	Capacity
A003	60x60(H)45mm	0.05L
A110	85x85x(H)80mm	0.15L

Rolling Pin



Item#	Size
RP-101	(L) 465mm

Breadform



Item#	Size	Capacity
RS0802	280x110x(H)83mm	1.5L

Terrine Mould V Shape

- Stainless steel in mirror polished finish

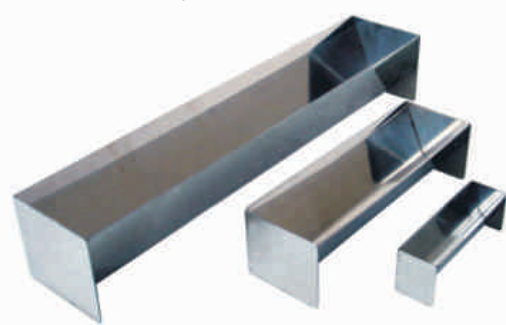

Item#	Size	Capacity
AP039	135x40x(H)45mm	Mini
AP033	260x80x(H)75mm	0.7L
AP029	500x100x(H)90mm	2L

Dariol Mould

- Anodised aluminium with rolled edge



Item#	Size	Item#	Size
N0871	Ø51x(H)52mm	N0873	Ø57x(H)65mm
N0872	Ø51x(H)64mm	N0874	Ø64x(H)64mm

Oven Glove



Item#	Size
GV2	(L) 360mm

STRUCTURE OF A FORGED KNIFE

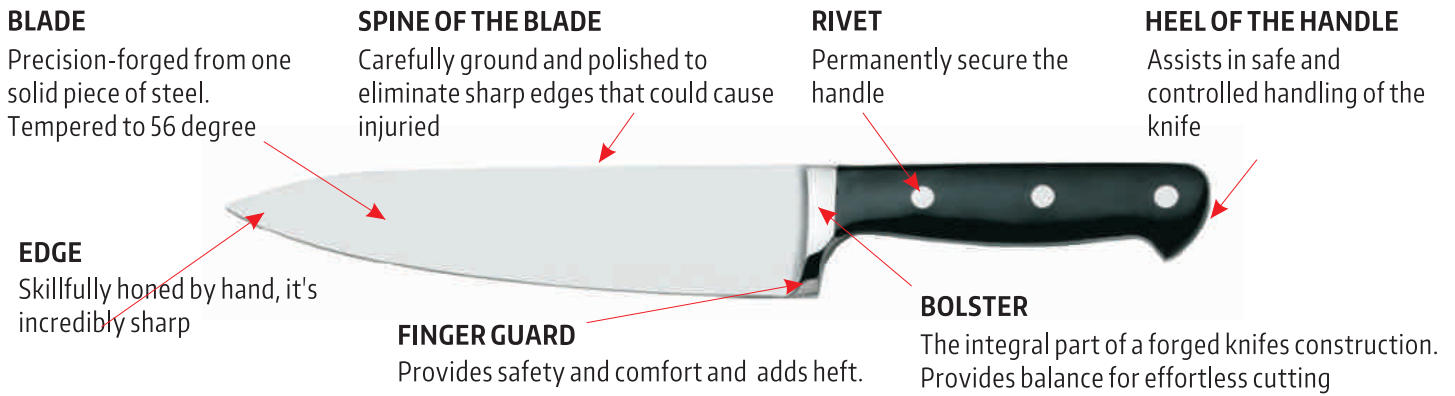

Classic Forged Knives

Item#	Desc.	Size	Item#	Desc.	Size	Item#	Desc.	Size	Item#	Desc.	Size	
●1501F	Chopper	180mm	●1503FA	Bread Knife	230mm	●1509F	Utility Knife	114mm	●1510F	Paring Knife	89mm	
●1502F	Cook's Knife	203mm	●1503F	Ham Slicer	200mm	●1515F	Sharpener	229mm	●1518F	Sharpener	270mm	
●1506F	Cook's Knife	152mm	●1504F	Carving Knife	203mm	●1513F	Poultry Shear					
●1508F	Boning Knife	152mm	●1507F	Carving Fork	152mm							

Professional Forged Knives

Item#	Desc.	Size	Item#	Desc.	Size	Item#	Desc.	Size	Item#	Desc.	Size	Item#	Desc.	Size	Item#	Desc.
●1501FD	Chopper	300mm	●1520FD	Cook's Knife	200mm	●1510FD	Paring Knife	185mm	●1587FD	Cheese Knife	245mm	●1507FD	Cheese Fork	185mm		
●1669FD	Cook's Knife	385mm	●1516FD	Bread Knife	203mm	●1584FD	Cheese Knife	220mm								
●1518FD	Cook's Knife	340mm	●1504FD	Ham Slicer	152mm	●1580FD	Cheese Knife	186mm								
●1503FD	Cook's Knife	295mm	●1591FD	Boning Knife	268mm											
●1519FD	Carving Knife	318mm	●1509FD	Utility Knife	227mm											
●1592FD	Slicer	230mm														

HOLLOW HANDLE KNIVES



Item#	Desc.	Size	Item#	Desc.	Size	Item#	Desc.	Size
•1501H	Cleaver	178mm	•1504H	Ham Slicer	203mm	•1515H	Sharpener	229mm
•1502H	Cook's Knife	203mm	•1509H	Utility	127mm	•1510H	Paring Knife	76mm
•1506H	Cook's Knife	152mm	•1509BH	Steak Knife	114mm	•1512H	Paring Knife	89mm
•1503H	Bread Knife	203mm	•1508H	Boning Knife	152mm	•1513H	Poultry Shear	
						•1507H	Carving Knife	203mm

SET KNIVES IN METAL CASE OR SLEEVES

11pcs Hollow Knives in Metal Case



Item#	Capacity
X1511H	11pcs Hollow Knives

12pcs Forged Knives in Metal Case



Item#	Capacity
X15-12F	12pcs Forged Knives

Nylon Knife Wallet with 6 Compartments



Item#	Size
KB-00A6	410 x 420mm

Nylon Knife Wallet with 9 Compartments



Item#	Size
KB-00A9	9 Compartments



HACCP (Hazard Analysis Critical Control Points) is an international principle defining the requirements for effective control of food safety. The HACCP system helps organisations focus on the hazards that affect food safety/hygiene and systematically identifies them by setting up critical control limits at critical points during the food production process.

This colour coded system, in 6 distinguishable colours, is the hygienic answer to eliminate cross-contamination in the kitchen, as recommended by experts in the catering sector. The concept behind the system is to use a different knife for preparing different types of food.

All models carry HACCP colours

Blue - for raw fish



Black - for general use



Brown - for salad and fruit



Green - for vegetables



Red - for raw meat



White - for dairy and bakery



Yellow - for cooked meats



Item#	Desc.	Size	Item#	Desc.	Size	Item#	Desc.	Size	Item#	Desc.	Size
• 6510S	Paring Knife	76mm	• 6505	Cook's Knife	159mm	• 6517S	Palette Knife	102mm	• 6510S	Paring Knife	76mm
• 6510	Paring Knife	89mm	• 6502S	Cook's Knife	190mm	• 6517	Palette Knife	203mm	• 6510	Paring Knife	89mm
• 6508	Boning Knife	152mm	• 6502	Cook's Knife	216mm	• 6509R	Boning Knife	127mm	• 6508	Boning Knife	152mm
• 6516S	Vegetable Knife	102mm	• 6502L	Cook's Knife	254mm	• 6509RL	Boning Knife	152mm	• 6516S	6516S Serrated	102mm

Item#	Desc.	Size	Item#	Desc.	Size	Item#	Desc.	Size	Item#	Desc.	Size	Item#	Desc.	Size
• 6507	Cook's Fork	152mm	• SC6509	Scalloped Utility Knife	127mm	• 6505	Fillet Knife	152mm	• 6507	Cook's Fork	152mm	• 6505	Fillet Knife	152mm
• SC6518	Scalloped Counter Knife	203mm	• 6504	Bread Knife	254mm	• 6504	Bread Knife	254mm	• SC6518	Scalloped Counter Knife	203mm	• 6504	Bread Knife	254mm
• SC6518L	Scalloped Counter Knife	254mm	• S6503	Slicer Serrated Blade	254mm	• S6503	Slicer Serrated Blade	254mm	• SC6518L	Scalloped Counter Knife	254mm	• S6503	Slicer Serrated Blade	254mm
• SC6503	Beef Scalloped Slicer	254mm	• S6503L	Slicer Serrated Blade	305mm	• S6503L	Slicer Serrated Blade	305mm	• SC6503	Beef Scalloped Slicer	254mm	• S6503L	Slicer Serrated Blade	305mm
• SC6503L	Beef Scalloped Slicer	305mm	• 1515F	Sharpener	229mm	• 1515F	Sharpener	229mm	• SC6503L	Beef Scalloped Slicer	305mm	• 1515F	Sharpener	229mm
• SC6503LL	Beef Scalloped Slicer	356mm	• 1518F	Sharpener	270mm	• 1518F	Sharpener	270mm	• SC6503LL	Beef Scalloped Slicer	356mm	• 1518F	Sharpener	270mm
• 6516	Utility Knife	89mm							• 6516	Utility Knife	89mm			
• 6508	Utility Knife	127mm							• 6508	Utility Knife	127mm			

MAGNETIC KNIFE RACKS

- PP + Magnet



Item#	Size
MK02	280X50X15

- PP + Magnet



Item#	Size	Hold Knives
MK01	550x50x15mm	8-10

- PP + Magnet



Item#	Size	Hold Knives
MK04	330X50X15	6

- PP + Magnet



Item#	Size	Hold Knives
MK21	380X50X15mm	7

STEAK KNIVES

Jumbo Steak Knife



Item#	Blade Length
JSK-127	127cm

Steak Knife



Item#	Blade Length
TSKR	118mm

Steak Knife



Item#	Blade Length
K-ED-01	115mm

Steak Knife



Item#	Blade Length
TSKP	118mm



Meat Dish Oval

- Available in stainless steel 18/10 or 14/4
- In mirror polished finish

Item#	Size
8308	200x140x(H)17mm
8309	225x160x(H)17mm
8310	255x180x(H)20mm
8312	300x220x(H)28mm
8314	355x220x(H)20mm
8316	400x260x(H)20mm
8318	450x290x(H)25mm
8320	500x350x(H)30mm
8322	560x340x(H)35mm
8324	610x420x(H)30mm

Vegetable Dish Oval

- Available in stainless steel 18/10 or 14/4
- In mirror polished finish

Item#	Size
83107	175x120x(H)30mm
83108	205x140x(H)30mm
83109	225x160x(H)40mm
83110	255x180x(H)40mm
83112	300x210x(H)40mm
83114	350x210x(H)40mm
83120	510x310x(H)50mm



Vegetable Dishes Oval w/ 2 Divisions

- Stainless steel 18/10 or 14/4
- In mirror polished finish



Item#	Size
83208	205x140x(H)30mm
83210	255x180x(H)40mm
83212	300x210x(H)40mm
83214	350x210x(H)40mm
83220	510x310x(H)50mm

Vegetable Dishes Oval w/ 3 Divisions

- Stainless steel 18/10 or 14/4
- In mirror polished finish



Item#	Size
83314	350x210x(H)40mm
83320	510x310x(H)50mm

Vegetable Dish Lids Oval

- Stainless steel 18/10 or 14/4
- In mirror polished finish



Item#	Size
83208L	190x130x(H)25mm
83210L	245x170x(H)25mm
83212L	290x200x(H)30mm
83214L	335x205x(H)40mm
83220L	455x290x(H)50mm

Serving Tray Oval

- Stainless steel tray with rolled edge
- Available in mirror or satin polished finish

Item#	Size
1623(1623M)	190x150x(H)10mm
1723(1723M)	265x195x(H)12mm
1823(1823M)	290x225x(H)12mm
1923(1923M)	230x175x(H)10mm



Serving Tray Round

- Stainless steel tray with rolled edge
- In mirror polished finish

Item#	Size
5310	Ø250x(H)20mm
5312	Ø295x(H)25mm
5314	Ø355x(H)25mm
5316	Ø415x(H)30mm

Serving Plate Round

- Stainless steel tray
- With decorated open edge
- In mirror polished finish



Item#	Size
G350P-C	Ø350X(H)10mm
G400P-C	Ø400X(H)15mm

Serving Plate Round

- Stainless steel tray
- With open edge
- In mirror polished finish



Item#	Size
G350	Ø350x(H)10mm
G400	Ø400x(H)15mm

Serving Plate Round

- Stainless steel tray
- With open edge
- In mirror polished finish



Item#	Size
VN321	Ø320(200)X(H)10MM

Beer Glass Tray

- Stainless steel tray
- With rolled edge
- In satin polished finish



Item#	Size
VN-324	Ø320X(H)40mm
VN-364	Ø360X(H)40mm

Round Cake Stand

- Stainless Steel 14/4
- Satin polished finish
- Enclosed foot



Item#	Size
CS-003	Ø300x(H)35mm
CS-0032	Ø320x(H)35mm

Round Cake Cover

- Polycarbonate
- Temperature: -30°C and +120°C



Item#	Inner Ø & height
PC5310L	Ø252x(H)65mm
PC5312L	Ø300x(H)85mm

Tray GN 1/1

- Stainless steel tray
- In mirror polished finish

Item#	Size
63253	530x320x(H)10mm

Tray GN 1/1 Deep

- Stainless steel tray
- In mirror polished finish

Item#	Size
63253-20MC	530x320x(H)20mm
63253-40MC	530x320x(H)40mm

Tray GN 1/1 Stackable

- Stainless steel tray
- In mirror polished finish

Item#	Size
63253DF	530x320x(H)20mm

Tray GN 1/1

- Stainless steel tray with decorated rim
- In mirror polished finish



Item#	Size
63253P-C	530x320x(H)10mm

Display/ Butcher's Tray

- Stainless steel tray
- with half rolled edge
- In mirror polished finish



Item#	Size
VN-332510	330x250x(H)10mm
VN-422806	420x280x(H)6mm

Meat Dish

- Stainless steel dish
- With rounded corners
- In matt polished finish



Item#	Size
VN2618	260x180x(H)25mm

Display Tray

- Stainless steel tray
- In mirror polished finish



Item#	Size
VN-20161	200x160x(H)10mm

Display Tray

- Stainless steel tray
- In mirror polished finish



Item#	Size
VN-30161	300x160x(H)10mm

Display Tray

- Stainless steel tray
- In mirror polished finish



Item#	Size
VN-31211	310x210x(H)10mm

SERVING TRIP NON-SLIP

Rectangular



Round & Oval



Fiber glass	Polycarbonate	Size
Item#	Item#	
FC1014F	FC1014	254 x 356mm
FC1216F	FC1216	305 x 406mm
FC1418F	FC1418	356 x 457mm
FC1520F	FC1520	381 x 508mm
FC1622F	FC1622	406 x 559mm
FC1826F	FC1826	457 x 660mm

Fiber glass	Polycarbonate	Size
Item#	Item#	
FC1100F	FC1100	Ø279mm
FC1400F	FC1400	Ø356mm
FC1600F	FC1600	Ø406mm
FC2500F	FC2500	Oval 635mm
FC2700F	FC2700	Oval 686mm
FC2900F	FC2900	Oval 737mm

SERVING TRAYS PP

- Material: Polypropylene

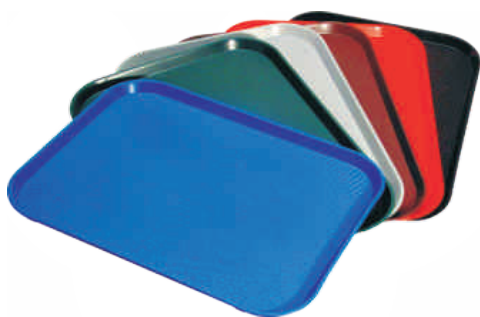

Item#	Size
PP1014	255 x 355mm
PP1216	305 x 306mm
PP1418	456 x 457mm

SQUEEZE BOTTLES

Standard Mouth Ø28.5mm

- PE Body + PP Cover



Item#	Capacity	Size
CS-BSD8	0.25ml	Ø50x(H)185mm
CS-BSD12	0.35ml	Ø60x(H)220mm
CS-BSD24	0.70ml	Ø70x(H)250mm

Wide Mouth Ø55mm

- PE Body + PP Cover



Item#	Capacity	Size
CS-BSDM16	0.5ml	Ø67x(H)200mm
CS-BSDM24	0.7ml	Ø70x(H)265mm
CS-BSDM32	0.95ml	Ø80x(H)265mm

CUTLERY TRAYS GN 1/1

4 Compartments



Item#	Size
P0062-6G	520x290x100mm

6 Compartments



Item#	Colour
P0062-6G	White
P0062-6BL	Black



Item#	Colour
P0062-6R	Red
P0062-6B	Blue

Cutlery Holders for 4 Baskets

- Stainless steel



Item#	Size
CUH-4	225x295x(H)215mm

Cutlery Holders for 6 Baskets

- Stainless steel



Item#	Size
CUH-6	375x295x(H)215mm

Cutlery Holders for 8 Baskets

- Stainless steel



Item#	Size
CUH-8	525x295x(H)215mm

CUTLERY BASKET

- Stainless steel



Item#	Size
CUC	Ø97x(H)137mm

Condiment Holders

- Stainless steel



Item#	Size	No of Holders
SN5403	230x150x(H)90mm	3
SN5404	305x150x(H)90mm	4
SN5405	380x150x(H)90mm	5
SN5406	455x150x(H)90mm	6

Condiment Holders

- Stainless steel with PP holders



Item#	Size	No of Holders
SN5403P	230x150x(H)90mm	3
SN5404P	305x150x(H)90mm	4
SN5405P	380x150x(H)90mm	5
SN5406P	455x150x(H)90mm	6

Ice-cream Scoop

- Aluminium



Item#	Size
IC-01	180mm
IC-02	180mm

Airpot with Glass Liner

- Stainless steel



Item#	Capacity
15KSS	1L
13KSS	1.9L

Napkin Holder

- Stainless steel



Item#
NP001

STAINLESS STEEL SAUCE BOAT



Item#	Size	Item#	Size	Item#	Size
10347	3oz	12347	6oz	11747	16oz
11347	5oz	11047	10oz		

MELAMINE WARE

Ramekins



Item#	Size	Capacity	Item#	Size	Capacity
• M100	Ø57x(H) 25mm	1oz	• M103	Ø80x(H)40mm	3oz
• M101	Ø62x(H) 38mm	1.5oz	• M104	Ø84x(H)45mm	4oz
• M102	Ø71x(H) 38mm	2oz			

Ramekins in Black



Item#	Size	Capacity
M101-BL	Ø62 x (H) 38mm	1.5oz
M102-BL	Ø71 x (H) 38mm	2oz
M103-BL	Ø80 x (H) 40mm	3oz

Dessert Plates



Item#	Size	Item#	Size
M1008	Ø203mm	M1010	Ø254mm
M1009	Ø229mm		

Bowl



Item#	Size
M5006	Ø152mm
M5007	Ø178mm

Coffee Mug



Item#	Size
M6025	Ø104x77x(H)65mm

Tall Mug



Item#
M238

COFFEE & TEA SET SERIES 10000



- Stainless Steel
- Dishwasher safe

Coffee Pot

Item#	Size
1137	12oz / 0.3L
1130	16oz / 0.5L
1132	20oz / 0.6L
1135	32oz / 1.0L
1156	48oz / 1.5L
1159	70oz / 2.0L
1100	100oz / 3.0L

Tea Pot

Item#	Size
1038	12oz / 0.3L
1030	16oz / 0.5L
1031	20oz / 0.6L
1034	32oz / 1.0L
1057	48oz / 1.5L
1058	70oz / 2.0L
1000	100oz / 3.0L

Milk Jug

Item#	Size
1021	1oz / 0.03L
1203	3oz / 0.1L
1205	5oz / 0.2L
1210	10oz / 0.3L
1220	20oz / 0.6L
1232	32oz / 1.0L
1248	48oz / 1.5L
1270	70oz / 2.2L
1200	100oz / 3.14L

Sugar Bowl

Item#	Size
1305	5oz / 0.2L
1310	10oz / 0.3L
1307L	7oz / 0.26L(w/Lid)
1310L	10oz / 0.3L(w/Lid)
1307HL	7oz / 0.26L(w/Hinged Lid)
1310HL	10oz / 0.3L(w/Hinged Lid)
1307HHL	7oz / 0.26L(w/Hinged Lid & Handle)
1310HHL	10oz / 0.3L(w/Hinged Lid & Handle)

COFFEE & TEA SET SERIES 30000



- Stainless Steel
- Dishwasher safe

Coffee Pot

Item#	Size
3112S	12oz / 0.3L
3120S	20oz / 0.6L
3132S	32oz / 1.0L
3148S	48oz / 1.5L
3172S	70oz / 2.0L

Tea Pot

Item#	Size
3005S	5oz / 0.125L
3008S	8oz / 0.25L
3012S	12oz / 0.35L
3020S	20oz / 0.6L
3032S	32oz / 1.0L

Milk Jug

Item#	Size
3205	5oz / 0.15L
3208	8oz / 0.25L
3212	12oz / 0.35L
3220	20oz / 0.6L
3232	32oz / 1.0L
3248	48oz / 1.5L
3272	72oz / 2.0L

Sugar Bowl

Item#	Size
3308	8oz / 0.25L
3312	12oz / 0.3L
3308L	8oz / 0.25L(w/Lid)
3312L	12oz / 0.3L(w/Lid)

COFFEE & TEA SET SERIES 90000



- Stainless Steel
- Dishwasher safe

Coffee Pot

Item#	Size
9012	12oz / 0.3L
9020	20oz / 0.6L
9032	32oz / 1.0L
9050	50oz / 1.6L

Tea Pot

Item#	Size
9112	12oz / 0.3L
9114	20oz / 0.6L
9120	32oz / 1.0L
9140	50oz / 1.6L

Milk Jug

Item#	Size
9005MP	5oz / 0.15L
9008MP	8oz / 0.25L
9012MP	12oz / 0.35L
9020MP	20oz / 0.6L
9024MP	24oz / 0.75L
9032MP	32oz / 1.0L
9050MP	50oz / 1.6L

Sugar Bowl

Item#	Size
9005SP	5oz / 0.15L
9008SP	8oz / 0.25L
9010SP	10oz / 0.3L
9020SP	20oz / 0.6L



A measuring jug is a kitchen utensil used primarily to measure the volume of liquid or bulk solid cooking ingredients such as milk, flour and sugar, regularly ranging from 500ml to 2000ml. It is with scale markings at different heights: the substance being measured is added to the jug until it reaches the

MEASURING JUG & MILK JUG

Measuring Jug

- Stainless Steel
- Dishwasher safe



Scale marking inside the jug



Item#	Size
YMJM-500	500ml
YMJM-700	700ml
YMJM-1000	1000ml
YMJM-1500	1500ml
YMJM-2000	2000ml

NEW!



Milk Jug with Non Stick Coating

Item#	Size
NS-3205	0.15L / 5oz
NS-3208	0.25L / 8oz
NS-3212	0.35L / 12oz
NS-3220	0.60L / 20oz
NS-3232	1.00L / 32oz
NS-3248	1.50L / 48oz
NS-3272	2.00L / 72oz

NEW!



Italian Style Stainless Steel Jug

- Stainless Steel
- Dishwasher safe



Item#	Size
IS2008	0.25L / 8oz
IS2012	0.35L / 12oz
IS2016	0.50L / 16oz
IS2024	0.70L / 24oz
IS2032	1.15L / 32oz
IS2050	1.60L / 50oz

NEW!





Every true barista knows that, like an artist, you need the proper tools for the job. The perfect cup of espresso doesn't just happen. It's an art and a science. From coffee pots to coffee mills to knockout drawers to decanters, we have the accessories you need to achieve that perfect cup.

KNOCK OUT DRAWS

The Knock-out Draws is the perfect way to dispose of used coffee grinds, and suitable for domestic and commercial use.

- Very sturdy stainless steel with replacable rubber coated steel knock bar
- Vented to prevent condensation
- Dishwasher Safe



S/S Knockout Draw



Item#	Size
D42	420 x 250 x (H) 90mm

Brasilia Knockout Draw



Item#	Size
D49	395 x 230 x (H) 130mm

S/S Knockout Draw



Item#	Size
D41	390 x 230 x (H) 100mm
D41B	390 x 230 x (H) 100mm (with bearing)

S/S Knockout Draw



Item#	Size
D40	400 x 300 x (H) 90mm

Metal Bar Rubber Coated

- Replacement Rubber Sleeve for the Rod of the Floor Standing Knock-out



Item#	Size
RB40	For item# D40
RB41	For item# D41

ACCESSORIES

S/S Grinder Pan in GN1/6



Item#	Desc.
D43	w/ rubber bar & base
D44	w/ rubber bar w/o base

Coffee Scoop



Item#	Size
D46	0.6oz
D45	2.8oz

Coffee Machine Cleaning Brush



Item#
PB-01

ICE BUCKETS & WINE COOLERS

Stainless Steel Ice Pail



Item#	Capacity
1705	5L

Stainless Steel Ice Pail



Item#	Capacity
1703	3L

Stainless Steel Ice Pail



Item#	Capacity
1702	3.5L

Plastic Wine Cooler w/ Chrome Rim



Item#	Capacity
1718	5L

Double Wall S/S Wine Cooler



Item#	Size	Capacity
1719	Ø120 x (H) 190mm	1.5L

Wine Cooler Stand



Item#
WCS-S

CHROME PLATED ICE CRUSHERS

- Material: ABS, Chrome



Item#	Size
VG-40005	160x130x(H)265mm

- Material: Zinc Alloy, Chrome



Item#	Size
VG-40002	160x130x(H)265mm

ICE SCOOPS

Aluminium Ice Scoops



Item#	Capacity	Item#	Capacity
AS06	6oz	AS24	24oz
AS12	12oz		

Polycarbonate Ice Scoops



Item#	Capacity	Item#	Capacity
P06	6oz	P64	64oz
P32	32oz		

COCKTAIL SHAKERS

S/S Cocktail Shaker



Item#	Capacity	Thickness
• 9083	200ml	0.7mm
• 9084	350ml	0.7mm
• 9085	500ml	0.7mm
• 9086	700ml	0.7mm

- Available in SS304/201/430

Item#

• **P000-3**

S/S Boston Shaker



Item#

Capacity

JW-BSK

Without rubber

JW-BSW

With rubber

JIGGERS



Item#	Capacity
TCL-2CL	2cl
TCL-3CL	3cl
TCL-5CL	5cl



Item#	Capacity
TM25	25ml
TM35	35ml
TM50	50ml



Item#	Capacity
TM-0104	1cl / 4cl
TM-0203	2cl / 3cl
TM-0204	2cl / 4cl

MUDDLERS

Wood Muddler



Item#	Size
BM-4	590x80x(H)17mm

ABS Muddler, Netted



Item#	Style	Size
P030	Netted	Ø27x210mm
P032	Netted	Ø39.5x240mm

ABS Muddler, Triangular



Item#	Style	Size
P031	Triangular	Ø27x210mm
P033	Triangular	Ø39.5x240mm

BAR MATS

Square, Rubber

- Material: TPE
- Available in Black & Brown



Item#	Size
JW-BMQ	450x310x(H)10mm

Strip, Rubber

- Material: TPE
- Available in Black & Brown



Item#	Size
BM-4	590x80x(H)17mm

Strip, Rubber

- Material: TPE



Item#	Size
JW-GSM	300x150x(H)10mm

FLAIR BOTTLE



Item#	Colour
FP-1	FBA, White

STORE N' POUR

- Material: AS Pour, PP Neck & Cover, PE Body
 - Available in 8 colours:
 Red, Orange, Yellow, Green, Blue
 Brown, Clear



Item#	Capacity	Size	Item#	Capacity	Size
JW-BSP0.5	0.5L	Ø90x260mm	JW-BSP2	2L	Ø120x350mm
JW-BSP1	1L	Ø90x330mm			

CORKSCREW & OPENER

Twin Level Corkscrew



Item#	Shape	Blade
BO115	Curve	Serrated

Waiter's Friend



Item#	Shape	Blade
BO115P	Curve	Plain

S/S Bottle Opener



Item#	Shape	Blade
BO116	Straight	Serrated
BO116P	Straight	Plain

Twin Level Corkscrew



Item#	Size
PS-02	120x30mm (Folded)

S/S Bottle Opener



Item#	Size
SP-802	88mm(Tumbling)

S/S Bottle Opener



Item#	Size
BO522	180 x 40 x 2mm

Twin Level Corkscrew



Item#	Size
CS-01	165x60mm

CORK EXTRACTOR, ZINC ALLOY

Gold Plated Version



Item#	Weight
BA-012Z	1.9kg

Chrome Plated Version



Item#	Weight
BA-013Z	1.9kg

ASHTRAYS

Stainless Steel Ashtray

- Available in SS201 or SS202



Item#	Size
SS-AT01	Ø80mm
SS-AT02	Ø100mm
SS-AT03	Ø120mm

Push Bottom Ashtray

- Body: Chrome



Item#	Size
ASH-10	Ø100mm

Push Bottom Ashtray

- Body: Chrome



Item#	Size
ASH-11	Ø110mm

Push Bottom Ashtray

- Body: Chrome in Black



Item#	Colour
ASH-10P	Ø100mm
ASH-11P	Ø110mm

CHAMPAGNE STOPPER



Item#	Spec
CS-1	Stainless Steel

WINE BOTTLE SEALER



Item#	Spec
BS001	W/ Rubber Cork

WINE POURER

Stainless Steel Wine Pourer



Item#	Spec
MSP-B	W/ Rubber Cork

Stainless Steel Wine Pourer



Item#	Spec
MSP-E	W/ Rubber Cork

Stainless Steel Pourer



Item#	Spec
MSP-D	W/ Rubber Cork

Stainless Steel Wine Pourer



Item#	Spec
MSP-A	

Stainless Steel Wine Pourer



Item#	Spec
SP-5	W/ Spongy Cork

Plastic & Chrome Pourer



Item#	Spec
PSP-CP	Plastic & Chrome

ALUMINIUM BRACKET

Bracket w/ Clamps for Shelf



Item#	Size
AB-31C-B	310mm

Bracket w/o Clamps for Wall



Item#	Size
AB-31-B	310mm

Aluminium Wall Fixing Bar



Item#	Size
WB05	130 x 40mm
WB09	230 x 40mm
WB15	380 x 40mm
WB17	430 x 40mm
WB21	530 x 40mm

Solo Head Plate



Item#	Spec
CM-02	Chrome Plated

OTHERS

Bar Shelf Liner

- Available in Clear & Black



Item#	Spec
NS003	600 X 5 mm
NS002	600 X 10 mm

Bar Caddy

- Material: ABS



Item#	Size
JW-BC	240x150x(H)105mm

Round Plastic Beer Tray

- Material: ABS



Item#	Size	Capacity
PP-14P	330x35mm	12 holes

Salt & Sugar Glass Rimmer

- Material: ABS



Item#	Size
JW-BSS	200x160x(H)70mm

Glass Brush, Aluminium Base

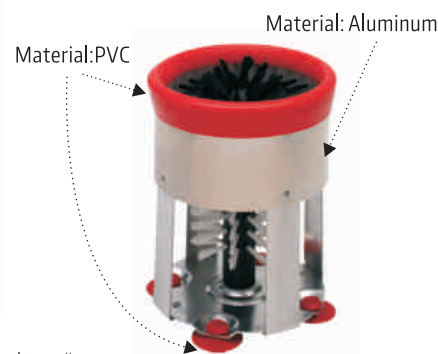

Item#
GB-A2

Glass Brush, Plastic Base

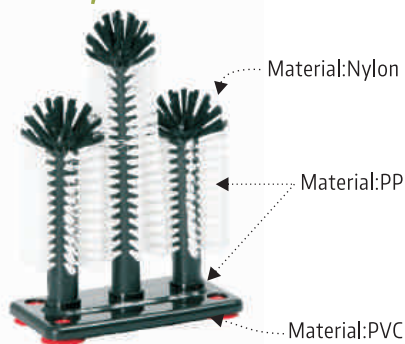

Item#	Size
GB-P2	187X100X(H)195mm

Glass Brush, Plastic Base



Item#	Size
GB-P	187X100X(H)195mm

Glass Brush - 2 Sponge 1 Brush



Item#	Size
GB-P2	187X100X(H)195mm



P2002 and P2003 are our best selling trolley. Made from hardwearing, engineering plastic, our kitchen trolley is a full size trolley measuring 900 x 500 x 1060mm made to a traditional design. Incorporating with special features that make our trolley with more loading capacity, more durable, and with longer operation life time.

PLASTIC 3-SHELF TROLLEY

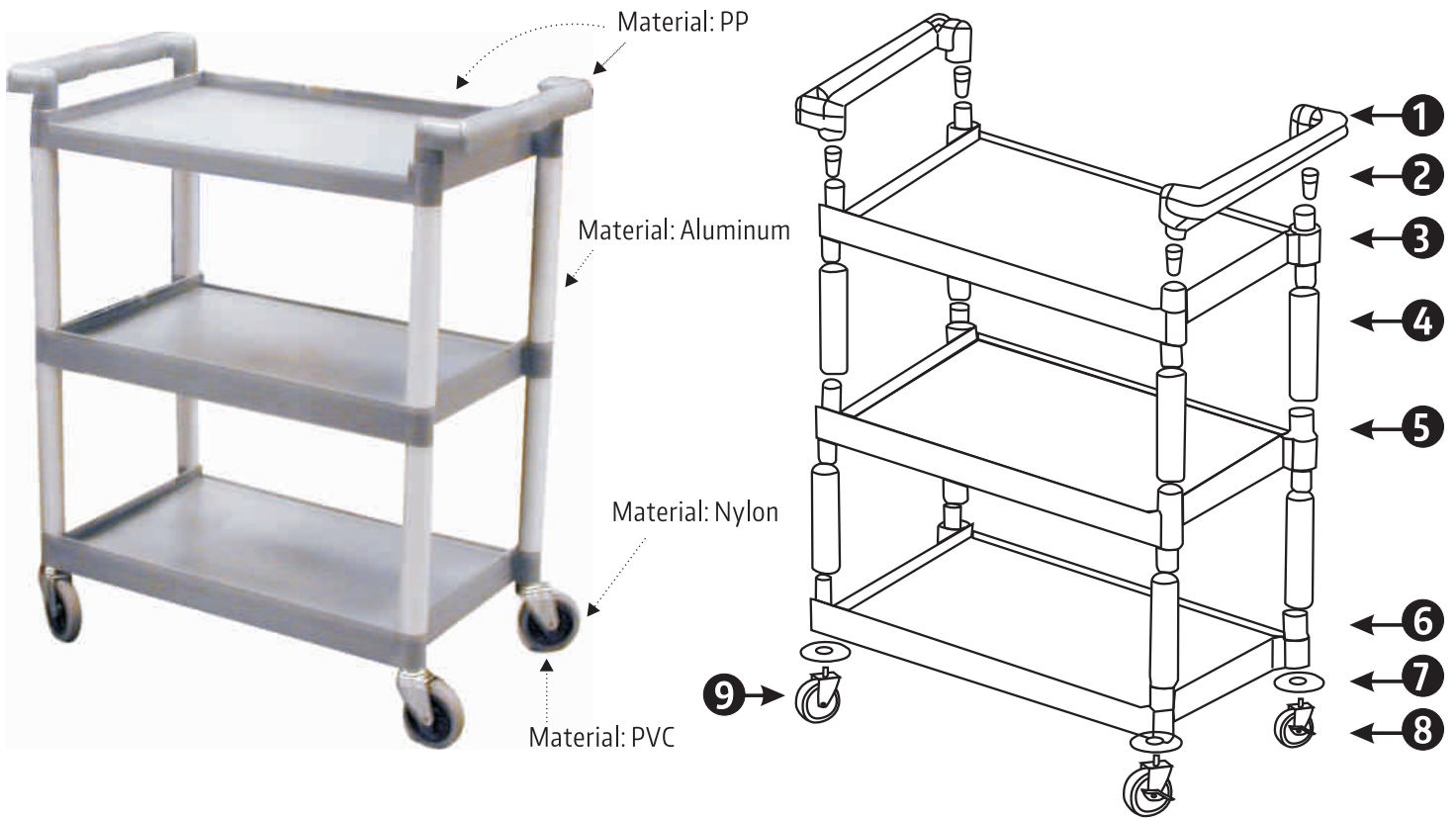

Heavy Duty Plastic Platform



Bumper Rubber



Anodized Supporting Pipe



Wheels axle with Bearing



Wheels w/ Brake

Item#	Size
P2002	813 x 410 x (H) 935mm
P2003	1035 x 495 x (H) 950mm

TROLLEY

Clearing Trolley



Item#	Size
BC0.8304	750 x 440 x (H) 970mm

Trolley

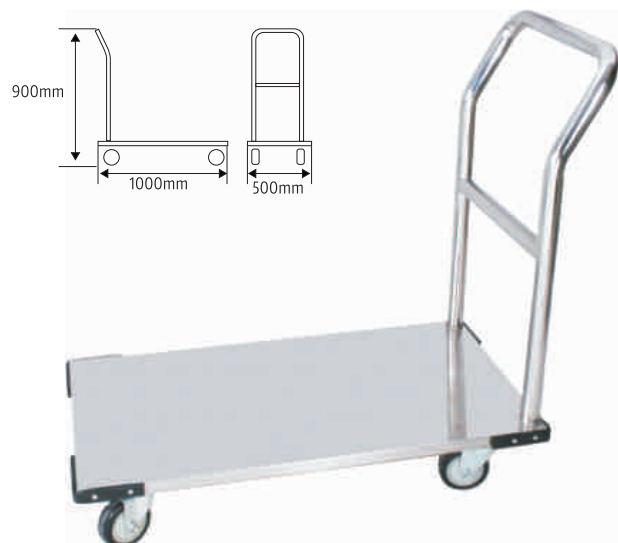

Item#	Size
BC0.2016	1000 x 500 x (H) 900mm

CLEARING TROLLEY

15 Tiers for Bake Pan



Item#	Size
TR-15A	630 x 470 x(H)1730mm

**15 Tiers for GN1/1
-With Brakes**



Item#	Size
TR-15	550 x 380 x(H)1730mm

20 Tiers for Bake Pan



Item#	Size
TR-20	630 x 470 x(H)1730mm

STAINLESS STEEL SHELF TROLLEY

3 Shelves



Item#	Size
T00030	710 x 405 x (H) 810mm
T10030	810 x 455 x (H) 855mm
T20030	860 x 535 x (H) 930mm

2 Shelves



Item#	Size
T00020	710 x 405 x (H) 810mm
T10020	810 x 455 x (H) 855mm
T20020	860 x 535 x (H) 930mm

3 Shelves w/ Water Basin



Item#	Size
TB20030	860 x 535 x (H) 930mm

2 Shelves w/ Water Basin



Item#	Size
TB20020	860 x 535 x (H) 930mm

LUGGAGE CART



Item#	Size
BC1.2001	1240x440x(H)1900mm



Item#	Size
BC9.2009	1240x640x(H)940mm

LUGGAGE TROLLEY

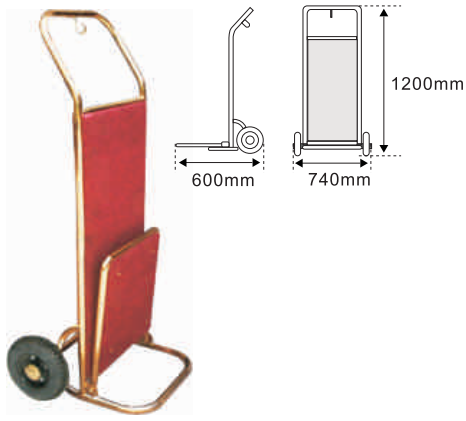

Item# **BC1.2001** Size 600x740x(H)1200mm

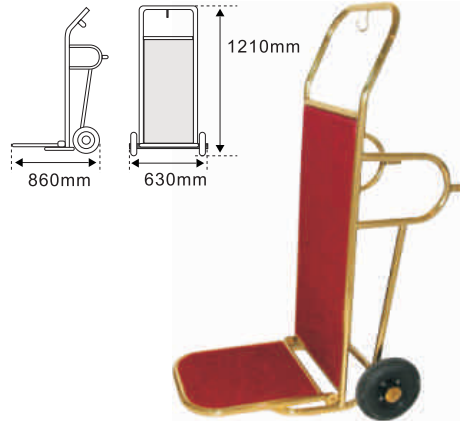

Item# **BC1.2003** Size 630x860x(H)1210mm

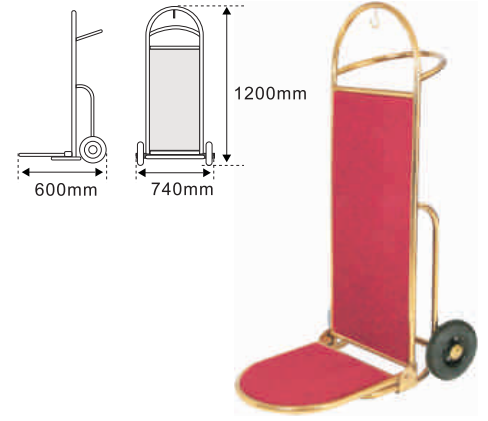

Item# **BC1.2018** Size 600x740x(H)1200mm

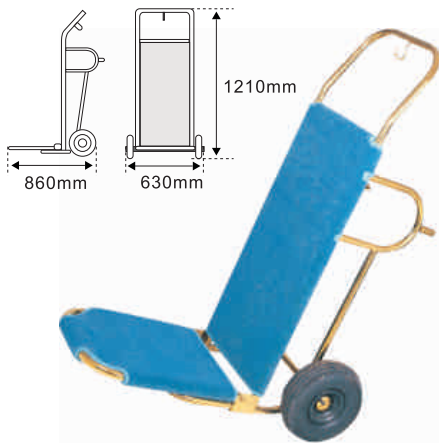

Item# **BC1.2222** Size 630 X 860 x (H)1210mm

WOODEN 3-SHELF TROLLEY



Item# **BC5.8896** Size 880 x 460 x (H)850mm



Item# **BC0.8232** Size 750 x 460 x (H)980mm

LAUNDRY TROLLEY & RACK



Item# **BC0.3203** Size 750 x 460 x (H)980mm



Item# **BC9.3212** Size 940 x 560 x (H)830mm



Item# **BC9.3202** Size 940 x 560 x (H)835mm



Item# **BC9.3213** Size 925 x 560 x (H)915mm



Item# **BC0.3300** Size 1200x530x(H)1690mm



Item# **BC0.3300ZA** Size 1200x540x(H)1710mm

CHALKBOARD

Large Double Sided External 'A' Board with Wood frame and Chalkboard

- Oak frame with metal side arm
- Dull blackboard finish

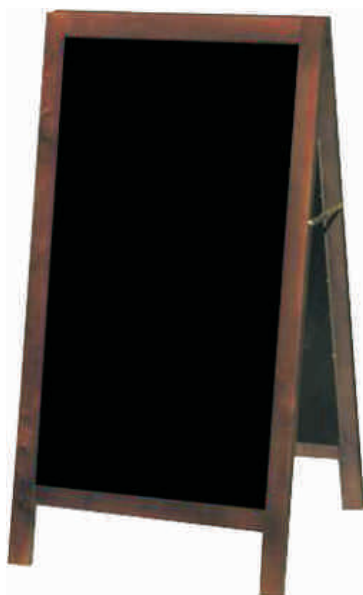

Item#	Size
MB-106A	1100 x 570mm

Menu Holder, Chalkboard A4, A5, A6

- Mirror or satin polished finish



Item#	Size	Capacity
MH-1511	1100 x 570mm	A6 size
MH-1521	1100 x 570mm	A5 size
MH-3021	1100 x 570mm	A4 size

Stained Wood Blackboard

- Pinewood
- Dull Blackboard Finish



Item#	Size	Frame
MB-01	305 x 457mm	45 x 12mm
MB-02	457 x 610mm	45 x 12mm
MB-03	610 x 914mm	45 x 12mm

Small Chalk Boards



- Oat Base
- Mahogany Base

Item#	Size
● HHB-01K	210 X (H) 320mm
● HHB-01M	210 X (H) 320mm

Table Bill Holder



Item#	Size
MC-001	(H)150mm

Bill Holder



Item#	Size	Item#	Size
BH-12	300mm	BH-32	820mm
BH-18	450mm	BH-36	910mm
BH-20	500mm	BH-40	1010mm
BH-24	610mm	BH-48	1220mm
BH-30	760mm		

Table Bill Holder



Item#	Size
TNS-U6	(H) 150mm
TNS-U8	(H) 200mm
TNS-U10	(H) 250mm
TNS-U14	(H) 300mm
TNS-U16	(H) 400mm
TNS-U18	(H) 450mm

COLOUR LABEL DISPENSER



Item#
LD-001

We supply different sized wine racks and storage shelves. We also supply racks and shelves of custom design to our customers specifications.



NEW!

Modular Shelving

Our modular shelving is ideal for different kinds of storage, and is at great use for each industry of refrigeration and hotel/ restaurant management.

The shelving features a combination of hard anodized aluminium posts and rails with high density PP plastic shelf sections and connectors.

The shelf sections can be easily assembled and disassembled to match the requirement in different situations.

FEATURES

- Easy assembling with no tools required
- Slotted design for great air circulation
- Easy addition or adjustment of shelves
- Extendable to any size
- Easy cleaning, dishwashers safe

Item#	Size
BC-AS4	1260 x 400 x (H) 1690mm

Wine Rack & Storage Shelves

Our wine rack is manufactured using steel tubes and wires. Standard racks are supplied with this "Chrome plated" finish. Many of our customers powder coated their racks especially if they are installing them inside their houses or restaurants.

Wine bottles are advised to store on a slight angle in order to keep corks moist at all times.

FEATURES

- Chrome-plated
- 4 adjustable shelves
- Fitted with adjustable feet
- Flatpack delivery

Item#	Size
WR-004	455 x 1840 x (H) 910mm





The Stainless Steel Workbench is perfect for all light duty applications that require the convenience and durability of stainless steel. All models are sound deadened to resist vibration with spongy filled at the bottom of the top surface.

Stainless Steel Work Bench with Back Splash

FEATURES

- Stainless Steel 18/0
- Flat pack design

Item#	Size
WB-08B	800 x 700 x (H) 850mm
WB-10B	1000 x 700 x (H) 850mm
WB-12B	1200 x 700 x (H) 850mm
WB-14B	1400 x 700 x (H) 850mm
WB-16B	1600 x 700 x (H) 850mm
WB-18B	1800 x 700 x (H) 850mm
WB-20B	2000 x 700 x (H) 850mm
WB-22B	2200 x 700 x (H) 850mm



Stainless Steel Work Bench without Back Splash

FEATURES

- Stainless Steel 18/0
- Flat pack design

Item#	Size
WB-08	800 x 700 x (H) 850mm
WB-10	1000 x 700 x (H) 850mm
WB-12	1200 x 700 x (H) 850mm
WB-14	1400 x 700 x (H) 850mm
WB-16	1600 x 700 x (H) 850mm
WB-18	1800 x 700 x (H) 850mm
WB-20	2000 x 700 x (H) 850mm
WB-22	2200 x 700 x (H) 850mm



Flatware/ Cutlery Rack



Item#
BCC

Plate Pleg Rack



Item#
BCP

Open Cup Rack

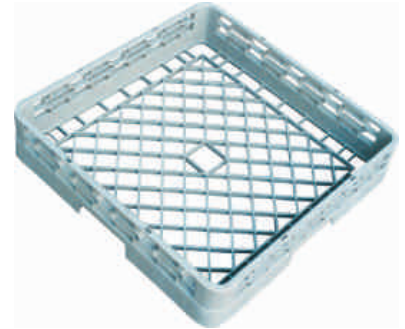

Item#
BCW

**Glass Rack & Extender
16 Compartments**



Item#
BCR-16 Glass Rack
BCE-16 Extender

**Glass Rack & Extender
25 Compartments**

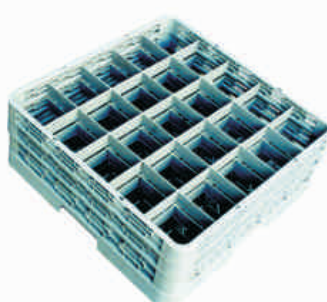

Item#
BCR-25 Glass Rack
BCE-25 Extender

**Glass Rack & Extender
46 Compartments**

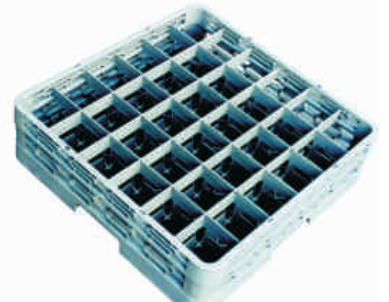

Item#
BCR-36 Glass Rack
BCE-36 Extender

**Glass Rack & Extender
49 Compartments**



Item#
BCR-49 Glass Rack
BCE-49 Extender

Pedal Bin 68L



Item# Capacity
BF07301A 68L

Stainless Steel Sack Holder



Item#
FSH-01

**Stainless Steel Waste Bin
- with Hydraulic Cover**



Item# Capacity
WB90L 90L

S/S Round Waste Bin



Item#
RWB-01

S/S Pedal Trash Bin



Item#	Capacity	Item#	Capacity
05A4	3L	05E4	20L
05B4	5L	05F4	30L
05D4	12L		

Ceramic Pepper Mills, Rubber Wood

NEW!



Item#	Size	Item#	Size
BCG12	Ø50x140mm	BCG15	Ø50x250mm
BCG13	Ø50x150mm	BCG17	Ø60x300mm
BCG14	Ø50x200mm		

Ceramic Pepper Mills, PU Colours

NEW!



Item#	Size	Item#	Size
BCG12A	Ø50x140mm	BCG15A	Ø50x250mm
BCG13A	Ø50x150mm	BCG17A	Ø60x300mm
BCG14A	Ø50x200mm		

Jumbo Salt & Pepper Mill



Item#	Size
5802	(H)65mm

Mini Salt & Pepper Mill



Item#	Size
754	(H)50mm

Sale & Pepper Set



Item#
BC-SC820

Cruet Set



Item#
BC-SC768

Cruet Set



Item#
BC-SC758N

Condiment Set



Item#
BC-SC767

Salad Set



Item#
BC-SC761A

Salad Set



Item#
BC-SC823Z

Salad Set



Item#
BC-SC760Z

Salad Set



Item#
BC-SC823

Salad Set



Item#
BC-SC733

Salad Set



Item#
BC-SC732

Salad Set



Item#
BC-SC810

Salad Set



Item#
BC-SC950

Salad Set



Item#
BC-SC952

Salad Set



Item#
BC-SC961

Salad Set



Item#
BC-SC734

Sugar Bowl



Item#
BC-SC762

Sugar Bowl



Item#
BC-SC826

POLYCARBONATE GLASSES

Granity Tumbler



Item#	Capacity
PC602280	280ml
PC604310	310ml

Granity Tumbler



Item#	Capacity
PC605390	390ml
PC603250	250ml

Granity Tumbler



Item#	Capacity
PC601330	330ml

General Tumbler



Item#	Capacity	Item#	Capacity
• PC104500	500ml	• PC102300	300ml
• PC103350	350ml	• PC101200	200ml

Granity Tumbler



Item#	Capacity	Item#	Capacity
• PC608350	400ml	• PC606350	350ml
• PC607350	350ml		

Pilsner Tumbler



Item#	Capacity
PC610390	390ml

Tulip



Item#	Capacity
PC613290	290ml

Pilsner Tumbler



Item#	Capacity
PC611300	300ml

Tumbler Hiball



Item#	Capacity
PC609340	340ml

Bowl



Item#	Capacity
PC105165	165ml

Milk Jug



Item#	Capacity
PC13672	72ml

INDEX A-Z

A

Adaptor Bar	P8
Airpot with Glass Liners	P36
All-Clad 3-Ply Conical Pans	P15
All-Clad 3-Ply Frying Pans	P15
All-Clad 3-Ply Sauce Pans	P15
All-Clad 3-Ply Stock Pot Pans	P15
Ashtrays	P44

B

Bakewell Pan, Aluminium	P26
Baking Box, Aluminium, w/o handles	P26
Baking Pan, Aluminium	P26
Baking Mould, Aluminium	P27
Baking Tray, Aluminium	P26
Banqueting Dishes	P32
Bar Caddys	P45
Bar Mats	P42
Bar Shelf Liners	P45
Beer Trays, ABS	P45
Beer Trays, Stainless Steel	P33
Blackboard, Pinewood	P49
Bill Holders	P49
Bird Nest Mould	P21
Boston Shakers	P42
Bottle Openers	P43
Bowls, Polycarbonate	P55
Brackets For Shelf	P45
Brackets For Wall	P45
Brasilia Knockout Draw	P40
Breadform	P27
Bull Shaped Sizzle Platter with Board	P18
Butcher's Tray	P32

C

Cake Stand	P33
Cake Cover	P33
Casseroles	P16
Cast Iron Pots	P16-17
Cast Iron Rectangular Dishes	P16
Ceramic Pepper Mills	P53
Cereal Dispensers 5L	P6
Chafer, Classic Full Size 9L	P1
Chafer, Classic Full Size 9L	P2
Chafer, Classic Round with Division	P3
Chafer, Classic Round 4.5L, 6.8L & 7.5L	P2
Chafer, Deluxe 2/3 Size 6L Hinged	P5
Chafer, Deluxe Full Size 9L Hinged	P5
Chafer, Deluxe Full Size 9L Roll Top	P1
Chafer, Deluxe Round 6L	P1

C

Chafer, Deluxe Round 6L Hinged	P5
Chafer, Economic Full Size 9L	P4
Chafer, Economic Half Size 4L	P4
Chafer, Economic Oval 7.5L	P4
Chafer, Economic Round 3.5L, 5L & 7L	P4
Chafer, Economic Round Jumbo 13.5L	P4
Chalkboards	P49
Champagne Stoppers	P44
Chip Baskets	P23
Chip Colander	P23
Chip Lifters	P22
Chip Shovels	P22
Chopping Board Racks	P24
Chopping Boards, HPDE & LDPE	P19
Chopping Boards, Bamboo	P19
Chopping Boards, Wooden	P19
Chrome Plated Wire Rack	P24
Citrus Juicers	P25
Cleaning Brush for Coffee Machine	P42
Clearing Trolleys, Plastic	P46
Clearing Trolleys 15 Tiers, Stainless Steel	P47
Clearing Trolleys 20 Tiers, Stainless Steel	P47
Cork Extractors	P43
Corkscrews	P43
Cocktail Shakers	P42
Cocotte, Mini	P34
Coffee Machine Cleaner	P40
Coffee Scoops	P40
Coffee & Tea Set Series 10000	P38
Coffee & Tea Set Series 30000	P38
Coffee & Tea Set Series 90000	P38
Colour Coded Knives	P30
Colour Label Dispensers	P49
Condiment Holders, Stainless Steel	P36
Condiment Holders, Polypropene	P36
Condiment Sets	P53-54
Cooling Racks	P24
Cruel Set	P53
Cutlery Basket	P36
Cutlery Cylinder	P36
Cutlery Cylinder Holder	P32
Cutlery Racks	P36

D

Dariol Mould, Aluminium	P27
Display Trays	P33-34
Display Trays Stackable	P34
Drain Plate	P8

E

Egg Slicer	P25
Egg Whisk	P22
Enamel Egg Dish	P17
Enamel Platter with Wooden Stand	P17
Encapsulated Conical Pans	P14
Encapsulated Frying Pans	P14
Encapsulated Sauce Pans	P14
Encapsulated Stock Pot Pans	P14

F

Fat Skimmer	P20
Fish Lifter	P21
Flair Bottles	P43
Food Tongs	P24
Forged Knives	P28
Fry Baskets	P23
Fry Baskets, Mini	P23
Fry Pans	P17
Fuel Holder	P3

G

Gastronorm Drain Shelf, Polycarbonate	P9
Gastronorm Drain Shelf, Stainless Steel	P8
Gastronorm Gril	P24
Gastronorm Pan Handle & Strainer	P8
Gastronorm Pan Holders	P8
Gastronorm Notched Covers, Stainless Steel	P7
Gastronorm Plain Covers, Polycarbonate	P9
Gastronorm Plain Covers, Stainless Steel	P7
Gastronorm Pans Perforated, Stainless Steel	P8
Gastronorm Pans, Polycarbonate	P9
Gastronorm Pans, Stainless Steel	P7
General Tumbler, Polycarbonate	P55
Glasses, Polycarbonate	P55
Glass Brushes	P45
Glass Brushes, Aluminium Base	P45
Glass Racks, 16/25/46/49 Compartments	P52
Glass Racks Extender, 16/25/46/49 Compartments	P52
Glass Trays, Stainless Steel	P31
Graters	P25
Granity Tumblers, Polycarbonate	P55
Griddle with Board	P17
Grill Pan Trivet	P24

H

Hammer	P25
Heating Plate for Chafing Dishes	P3
Hollow Handle Knives	P27

I

Ice Buckets	P41
Ice Crushers	P41
Ice Pails	P41
Ice Scoops	P41
Ice-cream Scoops	P36

J

Jigger	P42
Juice Dispenser, Classic Double 8Lx2	P6
Juice Dispenser, Classic Single 8L	P6
Juice Dispenser, Economic Circular 3L	P6
Juice Dispenser, Economic Circular 8L	P6
Juice Dispenser, Economic Hexagon 3L	P6
Juice Extractors	P23

K

Knife	P28-30
Knife Magnetic Rack	P31
Knife Wallets	P29
Knockout Draws	P40

L

Laundry Racks	P48
Laundry Trolleys	P48
Luggage Carts	P47-48

M

Magnetic Knife Rack	P31
Mandoline Slicers	P25
Meat Dishes Rectangular	P34
Meat Dishes Oval	P32
Meat Hammers	P25
Measuring Jugs	P39
Measuring Jugs, Non stick	P39
Measuring Jugs, Italian Style	P39
Melamin Bowl	P37
Melamin Coffee Mug	P37
Melamin Dessert Mug	P37
Melamin Ramekins	P37
Melamin Tall Mug	P37
Menu Holder, Chalkboard	P49
Metal Bar Rubber Coated	P40
Milk Jug w/ Non Stick Coating	P35
Milk Jug, Polycarbonate ///	P55
Modular Shelves	P50
Muddlers	P42

N

Napkin Holder	P36
Nickle Plated Skimmer	P20

N

Non-slip Trays, Fiber Glass	P35
Non-slip Trays, Polycarbonate	P35

O

Open Cup Racks	P47
Oval Gratin Dish	P16
Oval Sizzle Platter with Board	P17-18
Oven Gloves	P27
Oven Pans	P27
Oz Fuels	P3

P

Pasta Cooker Insert	P23
Pasta Slicer	P25
Pate Terrine Dish	P16
Pea Ladle	P21
Pedal Bins	P52
Pepper Mills	P53
Pig Shaped Sizzle platter with Board	P18
Pilsner Tumbler	P55
Plate Pleg Racks	P47
Plate Racks	P24
Polycarbonate Beer Hiball	P49
Polycarbonate Bowl	P49
Polycarbonate Round Cover	P31
Polycarbonate Milk Jug	P49
Polycarbonate Tumbler	P49
Potato Masher	P23
Potato Pounder	P23
Presentation Trays	P32
Prime Heat	P3
Pyramid Mould	P27

R

Rectangular Dish	P16
Reversible Double Griddles	P17
Ribbed Skille	P18
Rice Spoon Perforated	P21
Roasting Dishes	P26
Roasting Grill Racks	P24
Roll Top Covers	P2
Rolling Pins	P27
Round Gratin	P16
Round Sizzle Platter	P17

S

Sack Holders	P52
Salad Sets	P53-54
Salt & Pepper Mills	P53
Salt & Sugar Glass Rimmers	P45

S

Sandwich Bottom Conical Pans	P10-12
Sandwich Bottom Frying Pans	P10-12
Sandwich Bottom Sauce Pans	P10-12
Sandwich Bottom Stock Pot Pans	P10-12
Sauce Boat	P37
Serving Spoon	P21
Serving Spoon Perforated	P21
Serving Tong	P25
Serving Trays, Fiberglass	P35
Serving Trays, Polycarbonate.....	P35
Serving Trays, Polypropylene	P35
Serving Trays, Stainless Steel	P33
Shelf, Anodized Aluminium & PP	P50
Shelf Bracket	P24
Sizzle Platter	P17-18
Skillet	P18
Skimmer	P20-21
Soup Ladle	P21
Soup Station, Classic Rectangular	P3
Soup Station, Deluxe 11L, Hinged	P5
Soup Station, Deluxe Rect' 8L	P1
Soup Station, Deluxe Round 4L	P1
Soup Station, Economic American Style	P5
Soup Station, Economic European Style	P5
Spaghetti Baskets	P23
Squeeze Bottles, Standard Mouth	P35
Squeeze Bottles, Wide Mouth	P35
Steak Knives	P31
Step Bin	P52
Storage Shelf	P50
Store N' Pour	P43
Strainers	P20-21
Sugar Bowls	P54

T

Table Bill Holder	P49
Terrine Mould U Shape	P27
Terrine Mould V Shape	P27
Thimble Measures	P38
Tongs	P24
Trash Bins	P52
Trolleys, Plastic 3 Shelf	P46
Trolleys, Stainless Steel 2 Shelves	P47
Trolleys, Stainless Steel 2 Shelves with Water Basin	P47
Trolleys, Stainless Steel 3 Shelves	P47
Trolleys, Stainless Steel 3 Shelves with Water Basin	P47
Trolleys, Stainless Steel 15 Tiers	P47
Trolleys, Stainless Steel 20 Tiers	P47
Trolleys, Wooden 3 Shelves	P48
Tullip, Polycarbonate	P55

T

Tumbler, Polycarbonate	P55
Tumbler Highball, Polycarbonate	P55
Turners	P21
Turners, Perforated	P21
Twin Level Corkscrews	P43

V

Vegetable Dishes Oval	P32
Vegetable Dishes Oval with 2 Divisions	P32
Vegetable Dishes Oval with 3 Divisions	P32
Vegetable Dishes Lid Oval	P32
Vegetable Ladles	P21
Vegetable Slicer	P25
Vegetable Strainers	P21

W

Waiter's Friend	P43
Waste Bins	P52
Whisks, 8-Wire & 12-Wire	P22
Wire Mesh Skimmer	P20
Wire Mesh Strainer	P20
Wire Racks	P24
Wine Bottle Sealers	P44
Wine Cooler Stand	P41
Wine Cooler S/S Double Wall	P41
Wine Cooler Plastic	P41
Wine Pourers	P44
Wine Racks & Storage Shelves	P50
Wooden 3 Shelf Trolley	P48
Work Benches	P51

Inches - Millimetres

1"	=	25.4mm
2"	=	50.8mm
3"	=	76.2mm
4"	=	101.6mm
5"	=	127.0mm
6"	=	152.4mm
7"	=	177.8mm
8"	=	203.2mm
9"	=	228.6mm
10"	=	254.0mm

Millimetres - Inches

10mm	=	0.39"
20mm	=	0.79"
30mm	=	1.18"
40mm	=	1.57"
50mm	=	1.97"
60mm	=	2.36"
70mm	=	2.75"
80mm	=	3.14"
90mm	=	3.54"
100mm	=	3.93"

Ounces - Centilitres

5oz	=	14.2cl
10oz	=	28.4cl
15oz	=	42.6cl
20oz	=	56.8cl
25oz	=	71.0cl
30oz	=	85.2cl
35oz	=	100.0cl
40oz	=	113.6cl
45oz	=	127.8cl
50oz	=	142.0cl

Centilitres - Ounces

10cl	=	3.52oz
20cl	=	7.04oz
30cl	=	10.56oz
40cl	=	14.08oz
50cl	=	17.60oz
60cl	=	21.12oz
70cl	=	24.64oz
80cl	=	28.16oz
90cl	=	31.68oz
100cl	=	35.20oz

Pounds - Kilograms

1lb	=	0.454kg
2lb	=	0.907kg
3lb	=	1.361kg
4lb	=	1.814kg
5lb	=	2.268kg
6lb	=	2.722kg
7lb	=	3.175kg
8lb	=	3.629kg
9lb	=	4.082kg
10lb	=	4.540kg

Kilograms - Pounds

1kg	=	2.21lb
2kg	=	4.41lb
3kg	=	6.61lb
4kg	=	8.82lb
5kg	=	11.02lb
6kg	=	13.23lb
7kg	=	15.43lb
8kg	=	17.64lb
9kg	=	19.84lb
10kg	=	22.05lb

Fl.oz - Millilitres

100fl.oz	=	2841ml
200fl.oz	=	5682ml
300fl.oz	=	8523ml
400fl.oz	=	11364ml
500fl.oz	=	14205ml
600fl.oz	=	17046ml
700fl.oz	=	19887ml
800fl.oz	=	22728ml
900fl.oz	=	25569ml

Millilitres - Fl.oz

100ml	=	3.5fl.oz
200ml	=	7.0fl.oz
300ml	=	10.5fl.oz
400ml	=	14.0fl.oz
500ml	=	17.6fl.oz
600ml	=	21.1fl.oz
700ml	=	24.6fl.oz
800ml	=	28.2fl.oz
900ml	=	31.7fl.oz

Pints - Litres

1pt	=	0.568L
2pt	=	1.137L
3pt	=	1.705L
4pt	=	2.273L
5pt	=	2.841L
6pt	=	3.410L
7pt	=	3.978L
8pt	=	4.546L
9pt	=	5.114L

Litres - Pints

1L	=	1.760pt
2L	=	3.520pt
3L	=	5.279pt
4L	=	7.039pt
5L	=	8.799pt
6L	=	10.559pt
7L	=	12.318pt
8L	=	14.078pt
9L	=	15.838pt

Litres - Quarts

1L	=	1.057 US Qt
2L	=	2.113 US Qt
3L	=	3.170 US Qt
4L	=	4.227 US Qt
5L	=	5.283 US Qt
6L	=	6.340 US Qt
7L	=	7.397 US Qt
8L	=	8.454 US Qt
9L	=	9.510 US Qt
10L	=	10.567 US Qt

CONVERSION FORMULAR**To Convert**

Inches to Centimeters	2.54
Centimeters to Inches	0.3937
Feet to Metres	0.3048
Metres to Feet	3.2808
Pounds to Grams	453.592
Grams to Pounds	0.0022
Litres to Gallons	0.22
Gallons to Litres	4.546

Multiply by**CAPACITY**

1 cubic inch	=	27 cubic feet	=	16.387cm
1 cubic yard	=	4 gills	=	0.7646m
1 pint	=	8 pints	=	0.5683 litres
1 gallon	=		=	4.5461 litres



Best Choice M&P Limited

Flat 810, 8/F, Tower III, Enterprise Square,

9 Sheung Yuet Road, Kowloon Bay

Hong Kong

T | 852 2801 5018

F | 852 2801 5057

E | bcinfo@biznetvigator.com

W | www.bc-hk.com